



SERVICE & MAINTENANCE

Models

1532E2

1932E2

2032E2

2632E2

2646E2

3246E2

3120855

May 10, 2006



SECTION A. INTRODUCTION - MAINTENANCE SAFETY PRECAUTIONS

A.A GENERAL

This section contains the general safety precautions which must be observed during maintenance of the aerial platform. It is of utmost importance that maintenance personnel pay strict attention to these warnings and precautions to avoid possible injury to themselves or others, or damage to the equipment. A maintenance program must be followed to ensure that the machine is safe to operate.

⚠ WARNING

MODIFICATION OF THE MACHINE WITHOUT CERTIFICATION BY A RESPONSIBLE AUTHORITY THAT THE MACHINE IS AT LEAST AS SAFE AS ORIGINALLY MANUFACTURED, IS A SAFETY VIOLATION.

The specific precautions to be observed during maintenance are inserted at the appropriate point in the manual. These precautions are, for the most part, those that apply when servicing hydraulic and larger machine component parts.

Your safety, and that of others, is the first consideration when engaging in the maintenance of equipment. Always be conscious of weight. Never attempt to move heavy parts without the aid of a mechanical device. Do not allow heavy objects to rest in an unstable position. When raising a portion of the equipment, ensure that adequate support is provided.

⚠ WARNING

SINCE THE MACHINE MANUFACTURER HAS NO DIRECT CONTROL OVER THE FIELD INSPECTION AND MAINTENANCE, SAFETY IN THIS AREA RESPONSIBILITY OF THE OWNER/OPERATOR.

A.B HYDRAULIC SYSTEM SAFETY

It should be noted that the machines hydraulic systems operate at extremely high potentially dangerous pressures. Every effort should be made to relieve any system pressure prior to disconnecting or removing any portion of the system.

Relieve system pressure by cycling the applicable control several times with the engine stopped and ignition on, to direct any line pressure back into the reservoir. Pressure feed lines to system components can then be disconnected with minimal fluid loss.

A.C MAINTENANCE

⚠ WARNING

FAILURE TO COMPLY WITH SAFETY PRECAUTIONS LISTED IN THIS SECTION MAY RESULT IN MACHINE DAMAGE, PERSONNEL INJURY OR DEATH AND IS A SAFETY VIOLATION.

- NO SMOKING IS MANDATORY. NEVER REFUEL DURING ELECTRICAL STORMS. ENSURE THAT FUEL CAP IS CLOSED AND SECURE AT ALL OTHER TIMES.
- REMOVE ALL RINGS, WATCHES AND JEWELRY WHEN PERFORMING ANY MAINTENANCE.
- DO NOT WEAR LONG HAIR UNRESTRAINED, OR LOOSE-FITTING CLOTHING AND NECKTIES WHICH ARE APT TO BECOME CAUGHT ON OR ENTANGLED IN EQUIPMENT.
- OBSERVE AND OBEY ALL WARNINGS AND CAUTIONS ON MACHINE AND IN SERVICE MANUAL.
- KEEP OIL, GREASE, WATER, ETC. WIPED FROM STANDING SURFACES AND HAND HOLDS.
- USE CAUTION WHEN CHECKING A HOT, PRESSURIZED COOLANT SYSTEM.
- NEVER WORK UNDER AN ELEVATED BOOM UNTIL BOOM HAS BEEN SAFELY RESTRAINED FROM ANY MOVEMENT BY BLOCKING OR OVERHEAD SLING, OR BOOM SAFETY PROP HAS BEEN ENGAGED.
- BEFORE MAKING ADJUSTMENTS, LUBRICATING OR PERFORMING ANY OTHER MAINTENANCE, SHUT OFF ALL POWER CONTROLS.
- BATTERY SHOULD ALWAYS BE DISCONNECTED DURING REPLACEMENT OF ELECTRICAL COMPONENTS.
- KEEP ALL SUPPORT EQUIPMENT AND ATTACHMENTS STOWED IN THEIR PROPER PLACE.
- USE ONLY APPROVED, NONFLAMMABLE CLEANING SOLVENTS.

REVISION LOG

Original Issue - June 1998

Revised - March 5, 1999 (Added 3246E2)

Revised - September 15, 1999 (Added 3246E2 w/
Proportional Control)

Revised - April 17, 2001

Revised - January 16, 2002

Revised - April 25, 2002

May 15, 2002 - Revised

August 26, 2003 - Revised

June 25, 2004 - Revised

November 8, 2004 - Revised

May 10, 2006 - Revised

TABLE OF CONTENTS

SUBJECT - SECTION, PARAGRAPH	PAGE NO.
SECTION A - INTRODUCTION - MAINTENANCE SAFETY PRECAUTIONS	
A.A General	a-a
A.B Hydraulic System Safety	a-a
A.C Maintenance	a-a
SECTION 1 - SPECIFICATIONS	
1.1 Capacities	1-1
1.2 Component Data	1-1
1.3 Performance Data	1-1
1.4 Torque Requirements	1-3
1.5 Lubrication	1-3
1.6 Serial Number Locations	1-4
1.7 Limit Switches	1-4
1.8 Cylinder Specifications	1-4
1.9 Pressure Settings	1-5
1.10 Critical Stability Weights	1-5
1.11 Major Component Weights	1-5
SECTION 2 - PROCEDURES	
2.1 General	2-1
2.2 Servicing and Maintenance Guidelines	2-1
2.3 Lubrication Information	2-2
2.4 Cylinders - Theory of Operation	2-3
2.5 Valves - Theory of Operation	2-3
2.6 Component Functional Description	2-4
2.7 Wear Pads	2-4
2.8 Cylinder Checking Procedures	2-4
2.9 Lift Cylinder Removal and Installation	2-5
2.10 Lift Cylinder Repair	2-5
2.11 Brake Cylinder Repair	2-9
2.12 Steer Cylinder Repair	2-10
2.13 Tilt Switch Adjustment	2-12
2.14 Pressure Setting procedures	2-14
2.15 Limit Switch Adjustment	2-18
2.16 Door Adjustment	2-18
2.17 JLG SMART System™ Analyzer Kit Instructions	2-18
2.18 Machine Personality Settings	2-21
2.19 Machine Model Default Settings	2-23
2.20 Machine Configuration Information	2-24
2.21 Jlg Smart System™ Help Messages and Flash Codes	2-26
2.22 Analyzer Menu Structure	2-29
2.23 Preventive Maintenance and Inspection Schedule	2-35
SECTION 3 - TROUBLESHOOTING	
3.1 General	3-1
3.2 Troubleshooting Information	3-1
3.3 Hydraulic Circuit Checks	3-1

LIST OF FIGURES

FIGURE NO.	TITLE	PAGE NO.
1-1.	Serial Number Location	1-4
1-2.	Torque Chart	1-6
2-1.	Lift Cylinder Assembly	2-6
2-2.	Barrel Support	2-6
2-3.	Capscrew Removal	2-7
2-4.	Rod Support	2-7
2-5.	Rod Seal Installation	2-8
2-7.	Brake Cylinder Assembly	2-9
2-8.	Steer Cylinder Assembly	2-11
2-9.	Tilt Switch Leveling Manual Adjustment	2-13
2-10.	Tilt Switch Leveling Voltmeter Adjustment	2-13
2-11.	Control Valve Components	2-14
2-12.	Control Valve Components (3246E2 w/Proportional Control)	2-16
2-13.	Quick Welder™ Installation	2-17
2-14.	JLG SMART System™ Controller	2-18
2-15.	Organizational Chart	2-22
3-1.	Electrical Schematic - Non Proportional Control (Sheet 1 of 2)	3-4
3-2.	Electrical Schematic - Non Proportional Control (Sheet 2 of 2)	3-5
3-3.	Electrical Schematic - Proportional Control (Sheet 1 of 2)	3-6
3-4.	Electrical Schematic - Proportional Control (Sheet 2 of 2)	3-7
3-5.	Hydraulic Schematic - Non Propotional Drive	3-8
3-6.	Hydraulic Schematic - 3246E2 Propotional Control	3-9
3-7.	Harness and Cable Assembly - Non Proportional Control (Sheet 1 of 2)	3-10
3-8.	Harness and Cable Assembly - Non Proportional Control (Sheet 2 of 2)	3-11

LIST OF TABLES

TABLE NO.	TITLE	PAGE NO.
1-1	Torque Requirements	1-3
1-2	Hydraulic Oil	1-3
1-3	Lubrication Specifications	1-3
1-4	Cylinder Specifications	1-4
1-5	Critical Stability Weights	1-5
1-6	Major Component Weights	1-5
2-1	Cylinder Component Torque Specifications	2-8
2-2	Holding Valve Torque Specifications	2-8
2-3	Pressure Settings Chart	2-15
2-4	Machine Personality Settings	2-21
2-5	Machine Model Default Settings Chart	2-23
2-6	Machine Configuration Programming Information	2-24
2-7	Help Messages	2-26
2-8	JLG SMART System™ Flash Codes & Help Messages	2-27
2-9	Analyzer Menu Structure	2-29
2-10	Preventive Maintenance and Inspection Schedule	2-36
3-1	Electrical Troubleshooting Chart	3-2
3-2	Hydraulic System Troubleshooting Chart	3-3

SECTION 1. SPECIFICATIONS

1.1 CAPACITIES

Hydraulic Oil Tank

1932E2

11.4 liters at full mark on tank

9.5 liters at add mark on tank

2032E2/2632E2/2646E2/3246E2

14.8 liters at full mark on tank

12.9 liters at add mark on tank

Hydraulic System (Including Tank)

1932E2 - Approximately 15.0 liters

2032E2/2632E2/2646E2/3246E2 - Approximately 19.0 liters

1.2 COMPONENT DATA

Hydraulic Pump/Electric Motor Assembly

24 Volts DC motor w/Single section gear pump

1932E2 8.5 lpm

2032E2/2632E2/2646E2/3246E2 -11.4 lpm

Battery Charger

20 Amp SCR

120/240 Volts AC - 50 Hz input

24 Volts DC - 20 Amp output w/auto timer

Batteries (4)

1932E2/2032E2/2646E2 - 6 Volt, 220 Amp Hour

2632E2/3246E2 - 6 Volt, 245 Amp Hour

Steer/Drive System

Tires -1932E2

Standard - 12.5 x 4 - Solid, Non-Marking, Rib

Optional - 12.5x4 - Solid, Rib

Tires - 2032E2/2632E2/2646E2/3246E2

Standard - 16.00 x 5.00 - Solid, Non-Marking

Optional -16.00 x 5.00 - Solid, Rib

Parking Brake (rear dual wheel) - Single cylinder, spring applied, hydraulically released.

Drive Motors

1932E2 - 126 cm³ displacement

2032E2 - 229.4 cm³ displacement

2632E2 - 310.3 cm³ displacement

2646E2 - 265.5 cm³ displacement

3246E2 - 294 cm³ displacement

Hydraulic Filter - Inline

Return - Bypass Type

10 Microns Nominal

Platform Size

1932E2 - 0.8 m x 1.6 m

2032E2/2632E2 - 0.8 m x 2.1 m

2646E2/3246E2 - 1.1 m x 2.1 m

1.3 PERFORMANCE DATA

Travel Speed

1932E2

Low Speed - 2.1 kmh

Elevated Speed -1.1 kmh

Maximum Speed - 4.0 kmh

2032E2

Low Speed - 2.1 kmh

Elevated Speed - 1.1 kmh

Maximum Speed - 4.2 kmh

2632E2/2646E2

Low Speed - 2.1 kmh

Elevated Speed - 1.1 kmh

Maximum Speed - 3.6 kmh

3246E2

Low Speed - 2.1 kmh

Elevated Speed - 0.8 kmh

Maximum Speed - 3.2 kmh

SECTION 1 - SPECIFICATIONS

Gradeability

All Models - 25%

Inside Turning Radius

1932E2 - 0.5 m

2032E2/2632E2 - 1m

2646E2 - 1 m

3246E2 - 1.1 m

Lift (No Load in Platform)

1932E2

Up - 27 seconds

Down -26 seconds

2032E2

Up - 27-35 seconds

Down - 28-35 seconds

2632E2

Up - 34-42 seconds

Down - 39-47 seconds

2646E2

Up - 40-48 seconds

Down - 37-45 seconds

3246E2

Up - 56-64 seconds

Down - 45-55 seconds

Platform Capacity

1932E2 - 230 kg

2033E2 - 340 kg

2632E2 - 230 kg

2646E2 - 340 kg

3246E2 - 320 kg

Manual Platform Extension Capacity

All Models - 120 kg. - 1 person

Machine Weight

1932E2 - approx. 1360 kg

2032E2 - approx. 2091 kg

2632E2 - approx. 2415 kg

2646E2 - approx. 2086 kg

3246E2 - approx. 2812 kg

Wheelbase

1932E2 -1.3 m

2032E2/2632E2/2646E2/3246E2 - 1.7 m

Platform Height (Elevated)

1932E2 - 5.8 m

2032E2 - 6.1 m

2632E2/2646E2 - 7.9 m

3246E2 - 9.75 m

Platform Height (Stowed)

1932E2 - 1.0 m

2032E2 - 1.0 m

2646E2/3246E2 - 1.2 m

Machine Height (Stowed)

Standard Handrails

1932E2 - 2.0 m

2032E2 - 2.0 m

2632E2 - 1.2 m

2646E2 - 1.8 m

3246E2 - 2.3 m

Machine Length

1932E2 - 1.7 m

2032E2/2632E2/2646E2/3246E2 - 2.3 m

Machine Width

1932E2 - 0.8 m

2032E2 - 0.8 m

2646E2/3246E2 -1.2 m

Ground Clearance

With Platform Lowered

All Models - 8.0 cm

With Platform Elevated

(Pothole Protection System Lowered)

All Models - 1.9 cm

Maximum Tire Load

1932E2 - 492 kg

2032E2 - 662 kg

2632E2 - 885 kg

2646E2 - 746 kg

3246E2 - 1,065 kg

Maximum Bearing Pressure

1932E2 - 6.4 kg/cm²

2032E2 - 7.0 kg/cm²

2632E2 - 8.4 kg/cm²

2646E2 - 7.5 kg/cm²

3246E2 - 8.9 kg/cm²

1.4 TORQUE REQUIREMENTS

Table 1-1. Torque Requirements

Desrciption	Torque Value (Dry)	Interval Hours
Wheel Lugs	105-120 ft lb (147-168 Nm)	50
Wheel Hub To Drive Motor	125-150 ft lb* (169-203 Nm)	600

Torque nut to 169 -203 Nm (dry), then add extra torque to line up the slot with the hole in the shaft to install the cotter pin.

NOTE: When maintenance becomes necessary or a fastener has loosened, to determine proper torque value, refer to Figure 1-2., Torque Chart.

1.5 LUBRICATION

Hydraulic Oil

Table 1-2. Hydraulic Oil

HYDRAULIC SYSTEM OPERATING TEMPERATURE RANGE ^c	SAE VISCOSITY GRADE
0° F to +23° F (-18° C to -5° C)	10W
0° F to +210° F (-18° C to +99° C)	10W-20, 10W-30
50° F to +210° F (+10° C to +210° C)	20W-20

NOTE: Hydraulic oils must have anti-wear qualities at least to API Service Classification GL-3, and sufficient chemical stability for mobile hydraulic system service. JLG Industries recommends Mobilfluid 424 hydraulic oil, which has an SAE viscosity of 10W-30 and a viscosity index of 152. When temperatures remain consistently below 20° F (-7° C), JLG recommends the use of MobilDTE13M hydraulic oil.

NOTE: Aside from JLG recommendations, it is not advisable to mix oils of different brands or types, as they may not contain the same required additives or be of comparable viscosities. If use of hydraulic oil other than Mobilfluid 424 is desired, contact JLG Industries for proper recommendations.

Lubrication Specifications

Table 1-3. Lubrication Specifications

KEY	SPECIFICATIONS
MPG	Multipurpose Grease having a minimum dripping point of 350° F. Excellent water resistance and adhesive qualities, and being of extreme pressure type. (Timken OK 40 pounds minimum)
EPGL	Extreme Pressure Gear Lube (oil) meeting API service classification GL-5 or MIL-Spec MIL-L-2105
HO	Hydraulic Oil. API service classification GL-3, e.g. Mobilfluid 424.

SECTION 1 - SPECIFICATIONS

1.6 SERIAL NUMBER LOCATIONS

For machine identification, a serial number plate is affixed to the machine. On 2032E2/2632E2/2646E2 and 3246E2 the plate is located on the front, center of the machine frame, on 1932E2 it is located above the right rear tire. The serial number will also be stamped on the front center of the machine frame.

1.7 LIMIT SWITCHES

The machines are equipped with the following limit switches:

Tilt Alarm - Illuminates a light on the platform and sounds an alarm when the machine is elevated and out of level in any direction 2° or more.

High Drive Cut-Out - High drive speed is cut out when the platform is raised above the preset height per model as follows.

1932E2 - 2.6 m

2032E2 - 2.1 m

2632E2 (Australian Only) - 2.9 m

2632E2/2646E2 - 2.6 m

3246E2 - 2.8 m

1.8 CYLINDER SPECIFICATIONS

NOTE: All dimensions are given in inches (in), with the metric equivalent, centimeters (cm), given in parentheses.

Table 1-4. Cylinder Specifications

Description	Bore	Stroke	Rod Diameter
Lift Cylinder (1932E2)	3.00 (7.6)	32.00 (81.2)	2.00 (5.1)
Lift Cylinder (2032E2)	3.50 (8.9)	38.87 (98.7)	2.00 (5.1)
Lift Cylinder (2632E2)	3.50 (8.9)	38.94 (99.0)	2.00 (5.1)
Lift Cylinder (2646E2)	3.00 (7.6)	37.75 (95.8)	2.00 (5.1)
Lift Cylinder (3246E2)	3.5 (8.9)	38.94 (99.0)	2.00 (5.1)
Steer Cylinder (All Models)	1.50 (3.8)	6.25 (15.9)	0.75 (1.9)
Brake Cylinder (All Models)	2.00 (5.1)	1.75 (4.4)	1.00 (2.5)

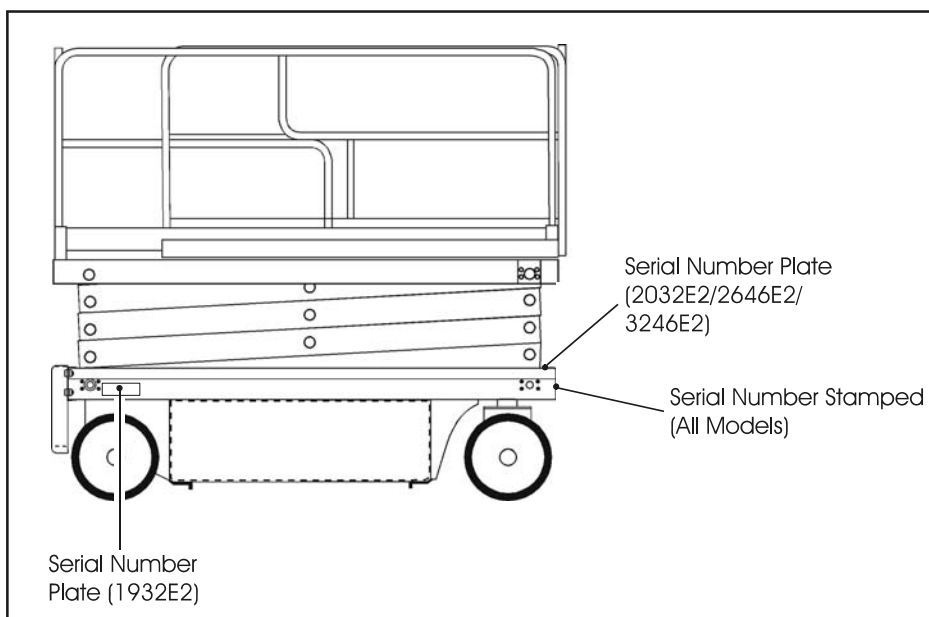

Figure 1-1. Serial Number Location

1.9 PRESSURE SETTINGS

Pressure Settings for Non Proportional Control Machines

Main Relief Max - 221 bar

Steer Relief Max - 138 bar

Lift Up Relief Max -

1932E2 - 159 bar

2033E2 - 152 bar

2632E2/2646E2/3246E2 - 165 bar

Pressure Settings for Proportional Control Machines

Main Relief Max - 207 bar +3.4/-0 bar (3000 psi +50/-0 psi)

Steer Relief Max - 145 bar (2100 psi)

Lift Up Relief Max - 145 bar (2100 psi)

1.11 MAJOR COMPONENT WEIGHTS

Table 1-6. Major Component Weights

COMPONENT	KG	LB
Platform (31 in. x 62 in.) - 1932E2	113	250
Platform (31 in. x 84 in.) - 2032E2/2632E2	176	388
Platform (46in. x 84 in.) - 2646E2/3246E2	204	450
Manual Platform Extension -1932E2	71	156
Manual Platform Extension -2032E2/2632E2	71	156
Manual Platform Extension -2646E2/3246E2	98	215
Arm Assembly - 1932E2 (Includes Lift Cylinder)	279	616
Arm Assembly - 2032E2 (Includes Lift Cylinder)	477	1,052
Arm Assembly - 2632E2 (Includes Lift Cylinder)	3,380	1,535
Arm Assembly - 2646E2 (Includes Lift Cylinder)	787	1,736
Arm Assembly - 3246E2 (Includes Lift Cylinder)	980	2,156
Chassis - 1932E2 w/Solid Tires	798	1,760
Chassis - 2032E2 w/Solid Tires (Includes 464 lb[211 kg] Counterweight)	1,054	2,324
Chassis - 2646E2 w/Solid Tires	876	1,932
Chassis - 3246E2 w/Solid Tires	1,022	2,253

1.10 CRITICAL STABILITY WEIGHTS



DO NOT REPLACE ITEMS CRITICAL TO STABILITY, SUCH AS BATTERIES OR SOLID TIRES, WITH ITEMS OF DIFFERENT WEIGHT OR SPECIFICATION. DO NOT MODIFY UNIT IN ANY WAY TO AFFECT STABILITY.

Table 1-5. Critical Stability Weights

Component	1932E2	2032E2/2632E2	2646E2/3246E2
Tires-Solid (each)	24lb (11kg)	31 lb (14 kg)	31 lb (14 kg)
Tires-Solid-Non-Marking (each)	24lb (11kg)	30 lb (14 kg)	30 lb (14 kg)
Motor/Pump Assembly	41 lb (19 kg)	41 lb (19 kg)	41 lb (19 kg)
Batteries - Std.- Each	63lb (29 kg)	63 lb (29 kg)	63 lb (29 kg)
Batteries - Standard- Combined	252 lb (114 kg)	252 lb (114 kg)	252 lb (114 kg)

SECTION 1 - SPECIFICATIONS

SIZE	THD	BOLT DIA. (CM)	THREAD STRESS AREA (SQ. CM)	VALUES FOR ZINC PLATED BOLTS ONLY												UNPLATED CAP SCREWS	
				SAE GRADE 5 BOLTS & GRADE 2 NUTS				SAE GRADE 8 BOLTS & GRADE 8 NUTS				UNBRAND 1960 SERIES SOCKET HEAD CAP SCREW WITH LOC-WEL PATCH				CLAMP LOAD (KG)	TORQUE (as received) N·M
				CLAMP LOAD (KG)	(DRY OR LOC. 263) N·M	(LUB.) N·M	(LOCTITE 262) 242 OR 271 N·M	CLAMP LOAD (KG)	(DRY OR LOC. 263) N·M	(LUB.) N·M	(LOCTITE 262) 242 OR 271 N·M	CLAMP LOAD (KG)	(DRY OR LOC. 263) N·M	(LUB.) N·M	(LOCTITE 242 OR 271) N·M		
4	40	0.2845	0.0153	172	1	1	1	1	245	2	1	1	1	—	—	—	
4	48	0.2845	0.0168	191	1	1	1	1	272	2	1	1	1	—	—	—	
6	32	0.3505	0.0232	263	2	2	2	2	372	3	2	2	2	—	—	—	
6	40	0.3505	0.0258	277	2	2	2	2	417	3	2	2	2	—	—	—	
8	32	0.4166	0.0356	408	4	3	3	3	572	5	4	4	4	—	—	—	
8	36	0.4166	0.0374	426	4	3	3	3	599	5	4	4	4	—	—	—	
10	24	0.4826	0.0445	508	5	4	4	4	717	7	5	5	5	—	—	—	
10	32	0.4826	0.0508	583	6	4	4	4	817	8	6	6	6	—	—	—	
1/4	20	0.6350	0.0808	916	11	9	9	9	1297	16	12	12	12	18	1442	18	
1/4	28	0.6350	0.0925	1052	14	10	10	10	1488	19	14	14	14	21	1651	19	
5/16	18	0.7938	0.1331	1515	23	18	22	26	2141	34	25	30	34	41	2377	34	
5/16	24	0.7938	0.1473	1678	26	19	23	29	2821	34	27	34	41	41	2631	37	
3/8	16	0.9525	0.1969	2241	41	31	38	48	3175	61	48	54	61	68	3493	61	
3/8	24	0.9525	0.2230	2540	48	34	43	54	3583	68	48	61	75	75	3983	68	
7/16	14	1.1112	0.2700	3085	68	48	61	75	4332	95	75	85	109	109	4822	95	
7/16	20	1.1112	0.3015	3425	75	68	68	81	4854	109	81	95	122	122	5384	102	
1/2	13	1.2700	0.3604	4105	102	75	92	115	5783	149	109	130	163	163	6437	149	
1/2	20	1.2700	0.4061	4854	122	88	108	136	6532	163	122	146	183	183	7253	156	
9/16	12	1.4288	0.4623	5262	149	109	133	163	7539	204	149	188	224	224	8256	210	
9/16	18	1.4288	0.5156	5874	163	122	148	183	8278	231	176	209	258	258	9208	224	
5/8	11	1.5875	0.5740	6532	204	149	183	224	9231	298	231	244	326	326	10251	285	
5/8	18	1.5875	0.6502	7394	231	176	207	258	10433	326	244	277	359	359	11612	298	
3/4	10	1.9050	0.8484	9662	353	271	325	387	13653	515	380	408	570	570	15150	495	
3/4	16	1.9050	0.9474	10796	407	298	363	448	15241	570	434	456	631	631	16919	542	
7/8	9	2.2225	1.1735	13336	583	434	523	644	18870	814	624	658	895	895	20956	793	
7/8	14	2.2225	1.2929	14697	637	475	576	705	20775	895	678	724	983	983	23088	861	
1	8	2.5400	1.5392	17509	868	651	785	915	23360	1220	922	931	1342	1342	27488	1173	
1	12	2.5400	1.6840	19142	949	719	858	997	27080	1356	1003	1079	1492	1492	30074	1241	
1-1/8	7	2.8575	1.9380	19187	1085	814	968	1139	31162	1736	1302	1396	1898	1898	34610	1681	
1-1/8	12	2.8575	2.1742	21546	1193	895	1087	1254	34927	1953	1464	1566	2136	2136	38828	1871	
1-1/4	7	3.1750	2.4613	24404	1519	1139	1368	1593	38554	2468	1844	1970	2712	2712	43954	2373	
1-1/4	12	3.1750	2.7254	27035	1681	1247	1516	1762	43818	2712	2034	2183	2983	2983	48671	2549	
1-1/2	6	3.4925	2.9337	29076	1980	1492	1792	2068	47174	3227	2413	2586	3559	3559	52391	3145	
1-1/2	12	3.4925	3.3401	33113	2278	1708	2042	2373	53570	3688	2766	2935	4068	4068	59648	3308	
1-1/2	6	3.8100	3.5687	35381	2630	1980	2379	2746	57380	4284	3200	3430	4712	4712	63731	4122	
1-1/2	12	3.8100	4.0132	39781	2983	2224	2676	3118	142200	4827	3607	3856	5322	5322	71669	4433	

Note: These torque values do not apply to cadmium plated fasteners.



SAE GRADE 5



SAE GRADE 8

SECTION 2. PROCEDURES

2.1 GENERAL

This section provides information necessary to perform maintenance on the scissor lift. Descriptions, techniques and specific procedures are designed to provide the safest and most efficient maintenance for use by personnel responsible for ensuring the correct installation and operation of machine components and systems.

NOTE: *Maintenance procedures provided in this section apply to all scissor lift models covered in this manual. Procedures that apply to a specific model will be so noted.*

⚠ CAUTION

WHEN AN ABNORMAL CONDITION IS NOTED AND PROCEDURES CONTAINED HEREIN DO NOT SPECIFICALLY RELATE TO THE NOTED IRREGULARITY, WORK SHOULD BE STOPPED AND TECHNICALLY QUALIFIED GUIDANCE OBTAINED BEFORE WORK IS RESUMED.

The maintenance procedures included consist of servicing and component removal and installation, disassembly and assembly, inspection, lubrication and cleaning. Information on any special tools or test equipment is also provided where applicable.

2.2 SERVICING AND MAINTENANCE GUIDELINES

General

The following information is provided to assist you in the use and application of servicing and maintenance procedures contained in this chapter.

Safety and Workmanship

Your safety, and that of others, is the first consideration when engaging in the maintenance of equipment. Always be conscious of weight. Never attempt to move heavy parts without the aid of a mechanical device. Do not allow heavy objects to rest in an unstable position. When raising a portion of the equipment, ensure that adequate support is provided.

Cleanliness

1. The most important single item in preserving the long service life of a machine is to keep dirt and foreign materials out of the vital components. Precautions have been taken to safeguard against this. Shields, covers, seals, and filters are provided to keep air, fuel, and oil supplies clean; however, these

items must be maintained on a scheduled basis in order to function properly.

2. At any time when air, fuel, or oil lines are disconnected, clear adjacent areas as well as the openings and fittings themselves. As soon as a line or component is disconnected, cap or cover all openings to prevent entry of foreign matter.
3. Clean and inspect all parts during servicing or maintenance, and assure that all passages and openings are unobstructed. Cover all parts to keep them clean. Be sure all parts are clean before they are installed. New parts should remain in their containers until they are ready to be used.

Components Removal and Installation

1. Use adjustable lifting devices, whenever possible, if mechanical assistance is required. All slings (chains, cables, etc.) should be parallel to each other and as near perpendicular as possible to top of part being lifted.
2. Should it be necessary to remove a component on an angle, keep in mind that the capacity of an eyebolt or similar bracket lessens, as the angle between the supporting structure and the component becomes less than 90°.
3. If a part resists removal, check to see whether all nuts, bolts, cables, brackets, wiring, etc., have been removed and that no adjacent parts are interfering.

Component Disassembly and Reassembly

When disassembling or reassembling a component, complete the procedural steps in sequence. Do not partially disassemble or assemble one part, then start on another. Always recheck your work to assure that nothing has been overlooked. Do not make any adjustments, other than those recommended, without obtaining proper approval.

Pressure Washing

It is a good practice to avoid pressure washing electronic components. Should pressure washing be utilized to wash areas containing electronic components, JLG Industries Inc. recommends a maximum pressure of 52 bar at a minimum distance of 30.5 cm. away. In addition, JLG Industries Inc. also recommends that these components are indirectly sprayed for brief time periods to avoid saturation.

Pressure-Fit Parts

When assembling pressure-fit parts, use an anti-seize or molybdenum disulfide base compound to lubricate the mating surface.

Bearings

1. When a bearing is removed, cover it to keep out dirt and abrasives. Clean bearings in nonflammable cleaning solvent and allow to drip dry. Compressed air can be used but do not spin the bearing.
2. Discard bearings if the races and balls (or rollers) are pitted, scored, or burned.
3. If a bearing is found to be serviceable, apply a light coat of oil and wrap it in clean (waxed) paper. Do not unwrap reusable or new bearings until they are ready to install.
4. Lubricate new or used serviceable bearings before installation. When pressing a bearing into a retainer or bore, apply pressure to the outer race. If the bearing is to be installed on a shaft, apply pressure to the inner race.

Gaskets

Check that holes in gaskets align with openings in the mating parts. If it becomes necessary to hand-fabricate a gasket, use gasket material or stock of equivalent material and thickness. Be sure to cut holes in the right location, as blank gaskets can cause serious system damage.

Bolt Usage and Torque Application

1. Use bolts of proper length. A bolt which is too long will bottom before the head is tight against its related part. If a bolt is too short, there will not be enough thread area to engage and hold the part properly. When replacing bolts, use only those having the same specifications of the original, or one which is equivalent.
2. Unless specific torque requirements are given within the text, standard torque values should be used on heat-treated bolts, studs, and steel nuts, in accordance with recommended shop practices.

Hydraulic Lines and Electrical Wiring

Clearly mark or tag hydraulic lines and electrical wiring, as well as their receptacles, when disconnecting or removing them from the unit. This will assure that they are correctly reinstalled.

Hydraulic System

1. Keep the system clean. If evidence of metal or rubber particles is found in the hydraulic system, drain and flush the entire system.
2. Disassemble and reassemble parts on clean work surface. Clean all metal parts with non-flammable cleaning solvent. Lubricate components, as required, to aid assembly.

Lubrication

Service applicable components with the amount, type, and grade of lubricant recommended in this manual, at the specified intervals. When recommended lubricants are not available, consult your local supplier for an equivalent that meets or exceeds the specifications listed.

Batteries

Clean batteries, using a non-metallic brush and a solution of baking soda and water. Rinse with clean water. After cleaning, thoroughly dry batteries and coat terminals with an anti-corrosion compound.

Lubrication and Servicing

Components and assemblies requiring lubrication and servicing are shown in Section 1.

2.3 LUBRICATION INFORMATION

Hydraulic System

1. The primary enemy of a hydraulic system is contamination. Contaminants enter the system by various means, e.g., using inadequate hydraulic oil, allowing moisture, grease, filings, sealing components, sand, etc., to enter when performing maintenance, or by permitting the pump to cavitate due to insufficient system warm-up or leaks in the pump supply (suction) lines.
2. The design and manufacturing tolerances of the component working parts are very close, therefore, even the smallest amount of dirt or foreign matter entering a system can cause wear or damage to the components and generally results in faulty operation. Every precaution must be taken to keep hydraulic oil clean, including reserve oil in storage. Hydraulic system filters should be checked, cleaned, and/or replaced as necessary, at the specified intervals required in Section 1. Always examine filters for evidence of metal particles.

3. Cloudy oils indicate a high moisture content which permits organic growth, resulting in oxidation or corrosion. If this condition occurs, the system must be drained, flushed, and refilled with clean oil.
4. It is not advisable to mix oils of different brands or types, except as recommended, as they may not contain the same required additives or be of comparable viscosities. Good grade mineral oils, with viscosities suited to the ambient temperatures in which the machine is operating, are recommended for use.

NOTE: Metal particles may appear in the oil or filters of new machines due to the wear-in of meshing components.

Hydraulic Oil

1. Refer to Section 1 for recommendations for viscosity ranges.
2. JLG recommends Mobilfluid 424, which has an SAE viscosity of 10W-30 and a viscosity index of 152.

NOTE: Start-up of hydraulic system with oil temperatures below -26°C (-15°F) is not recommended. If it is necessary to start the system in a sub-zero environment, it will be necessary to heat the oil with a low density, 100VAC heater to a minimum temperature of -26°C (-15°F).

3. The only exception to the above is to drain and fill the system with Mobil DTE 13M oil or its equivalent. This will allow start up at temperatures down to -29°C (-20°F). However, use of this oil will give poor performance at temperatures above 49°C (120°F). Systems using DTE 13M oil should not be operated at temperatures above 94°C (200°F) under any condition.

Changing Hydraulic Oil

1. Use of any of the recommended crankcase or hydraulic oils increases JLG's recommended oil change interval to 800 hours. However, filter elements must be changed after the first 50 hours of operation and every 400 hours thereafter. When changing the oil, use only those oils meeting or exceeding the specifications appearing in this manual. If you are unable to obtain the same type of oil supplied with the machine, consult your local supplier for assistance in selecting the proper equivalent. Avoid mixing petroleum and synthetic base oils.
2. Use every precaution to keep the hydraulic oil clean. If the oil must be poured from the original container into another, be sure to clean all possible contaminants from the service container. Always clean the mesh element of the filter and replace the cartridge any time the system oil is changed.

3. While the unit is shut down, a good preventive maintenance measure is to make a thorough inspection of all hydraulic components, lines, fittings, etc., as well as a functional check of each system, before placing the machine back in service.

Lubrication Specifications

Specified lubricants, as recommended by the component manufacturers, are always the best choice, however, multi-purpose greases usually have the qualities which meet a variety of single purpose grease requirements. Should any question arise regarding the use of greases in maintenance stock, consult your local supplier for evaluation. Refer to Table 1-2 for an explanation of the lubricant key designations appearing in the Lubrication Chart.

2.4 CYLINDERS - THEORY OF OPERATION

Cylinders are of the double acting type. The Steer systems incorporate double acting cylinders. A double acting cylinder is one that requires oil flow to operate the cylinder rod in both directions. Directing oil (by actuating the corresponding control valve to the piston side of the cylinder) forces the piston to travel toward the rod end of the barrel, extending the cylinder rod (piston attached to rod). When the oil flow is stopped, movement of the rod will stop. By directing oil to the rod side of the cylinder, the piston will be forced in the opposite direction and the cylinder rod will retract.

A holding valve is used in the Lift circuit to prevent retraction of the cylinder rod should a hydraulic line rupture or a leak develop between the cylinder and its related control valve.

2.5 VALVES - THEORY OF OPERATION

Solenoid Control Valves (Bang-Bang)

Control valves used are four-way three-position solenoid valves of the sliding spool design. When a circuit is activated and the control valve solenoid energizes, the spool is shifted and the corresponding work port opens to permit oil flow to the component in the selected circuit, with the opposite work port opening to reservoir. Once the circuit is deactivated (control returned to neutral), the valve spool returns to neutral (center) and oil flow is then directed through the valve body and returns to reservoir. A typical control valve consists of the valve body, sliding spool, and two solenoid assemblies. The spool is machine fitted in the bore of the valve body. Lands on the spool divide the bore into various chambers, which, when the spool is shifted, align with corresponding ports in the valve body open to common flow. At the same time other ports would be blocked to flow. The spool is spring-loaded to center position, therefore when the control is

SECTION 2 - PROCEDURES

released, the spool automatically returns to neutral, prohibiting any flow through the circuit.

Relief Valves

Relief valves are installed at various points within the hydraulic system to protect associated systems and components against excessive pressure. Excessive pressure can be developed when a cylinder reaches its limit of travel and the flow of pressurized fluid continues from the system control. The relief valve provides an alternate path for the continuing flow from the pump, thus preventing rupture of the cylinder, hydraulic line or fitting. Complete failure of the system pump is also avoided by relieving circuit pressure. The relief valve is installed in the circuit between the pump outlet (pressure line) and the cylinder of the circuit, generally as an integral part of the system valve bank. Relief pressures are set slightly higher than the load requirement, with the valve diverting excess pump delivery back to the reservoir when operating pressure of the component is reached.

Crossover Relief Valves

Crossover relief valves are used in circuits where the actuator requires an operating pressure lower than that supplied to the system. When the circuit is activated and the required pressure at the actuator is developed, the crossover relief diverts excess pump flow to the reservoir. Individual, integral reliefs are provided for each side of the circuit.

2.6 COMPONENT FUNCTIONAL DESCRIPTION

Hydraulic Pump

The main hydraulic pump is an integral part of the electric motor/pump assembly, located at the rear of the battery and ground control tray on the frame of the machine. The pump is a single section pump that provides an output of 11.4 lpm.

2.7 WEAR PADS

Sliding Pads

The original thickness of the sliding pads is 47.6 mm. Replace sliding pads when they are worn to 42.7 mm.

2.8 CYLINDER CHECKING PROCEDURES

NOTE: *Cylinder checks must be performed any time a cylinder component is replaced or when improper system operation is suspected.*

Cylinder w/o Holding Valves - Brake Cylinder and Steer Cylinder

⚠ IMPORTANT

OPERATE FUNCTIONS FROM GROUND CONTROL STATION ONLY.

⚠ WARNING

DO NOT FULLY EXTEND CYLINDER TO END OF STROKE. RETRACT CYLINDER SLIGHTLY TO AVOID TRAPPING PRESSURE.

1. Using all applicable safety precautions, activate motor and fully extend cylinder to be checked. Shut down motor.
2. Carefully disconnect hydraulic hose from retract port of cylinder. There will be initial weeping of hydraulic fluid which can be caught in a suitable container. After the initial discharge, there should be no further leakage from the retract port.
3. Activate motor and activate cylinder extend function. Check retract port for leakage.
4. If cylinder leakage is 6-8 drops per minute or more, piston seals are defective and must be replaced. If cylinder retract port leakage is less than 6-8 drops per minute, carefully reconnect hose to retract port and retract cylinder.
5. With cylinder fully retracted, shut down motor and carefully disconnect hydraulic hose from cylinder extend port.
6. Activate motor and activate cylinder retract function. Check extend port for leakage.
7. If cylinder leakage is 6-8 drops per minute or more, piston seals are defective and must be replaced. If extend port leakage is less than 6-8 drops per minute, carefully reconnect hose to extend port, then activate cylinder through one complete cycle and check for leaks.

Cylinders w/Single Holding Valves - Lift Cylinder

⚠ IMPORTANT

OPERATE ALL FUNCTIONS FROM GROUND CONTROL STATION ONLY.

- Using all applicable safety precautions, activate hydraulic system.

⚠ WARNING

WHEN WORKING ON THE LIFT CYLINDER, RAISE THE PLATFORM COMPLETELY AND SUPPORT THE PLATFORM USING A SUITABLE OVERHEAD LIFTING DEVICE.

⚠ WARNING

DO NOT FULLY EXTEND LIFT CYLINDER TO END OF STROKE. RETRACT CYLINDER SLIGHTLY TO AVOID TRAPPING PRESSURE.

- Raise platform completely then retract cylinder slightly to avoid trapping pressure. Place a suitable overhead lifting device approximately 2.5 cm (1 in) below the platform.
- Shut down hydraulic system and allow machine to sit for 10-15 minutes. Carefully remove hydraulic hoses from cylinder port block.
- There will be initial weeping of hydraulic fluid, which can be caught in a suitable container. After the initial discharge, there should not be any further leakage from the ports. If leakage continues at a rate of 6-8 drops per minute or more, the holding valve is defective and must be replaced.
- If no repairs are necessary or when repairs have been made, carefully reconnect hydraulic hoses to the appropriate ports.
- Remove lifting device from platform, activate hydraulic system and run cylinder through one complete cycle to check for leaks.

2.9 LIFT CYLINDER REMOVAL AND INSTALLATION

Lift Cylinder Removal

- Place the machine on a flat and level surface. Raise the platform and attach a suitable lifting device to the platform.
- Remove the bolts and locknuts securing the cylinder to the upper inner arm assembly. Drop the cylinder out of the saddle on the inner arm assembly.

- Retract the lift cylinder rod completely.
- Tag and disconnect the hydraulic lines, then cap the lift cylinder hydraulic lines and ports.
- Remove the bolts and locknuts securing the barrel end to the lower arm assembly.
- Carefully remove the cylinder from the scissor lift and place in a suitable work area.

Lift Cylinder Installation

- Install lift cylinder in place using suitable slings, aligning barrel end in lower arm assembly cylinder saddle.
- After the cylinder barrel is in place, Secure it with the bolts and locknuts.
- Remove cylinder port plugs and hydraulic line caps and correctly attach lines to cylinder ports.
- Extend the cylinder rod until the cylinder head aligns with upper inside cylinder saddle. Set the head of the cylinder in the saddle and replace the bolts and locknuts.
- Lower platform to stowed position and shut down motor. Check hydraulic fluid level and adjust accordingly.

2.10 LIFT CYLINDER REPAIR

Disassembly

⚠ IMPORTANT

DISASSEMBLY OF THE CYLINDER SHOULD BE PERFORMED ON A CLEAN WORK SURFACE IN A DIRT FREE WORK AREA. BE SURE TO CLEAN ALL DIRT OR OTHER FOREIGN SUBSTANCES FROM CYLINDER OPENINGS - PARTICULARLY AT THE HEAD.

- Connect a suitable auxiliary hydraulic power source to the cylinder port block fitting.

⚠ WARNING

DO NOT FULLY EXTEND CYLINDER TO END OF STROKE. RETRACT CYLINDER SLIGHTLY TO AVOID TRAPPING PRESSURE.

- Operate the hydraulic power source and extend the cylinder. Shut down and disconnect the power source. Adequately support the cylinder rod, if necessary
- If applicable, remove the cartridge-type holding valve and fittings from the cylinder port block. Discard o-rings.

SECTION 2 - PROCEDURES

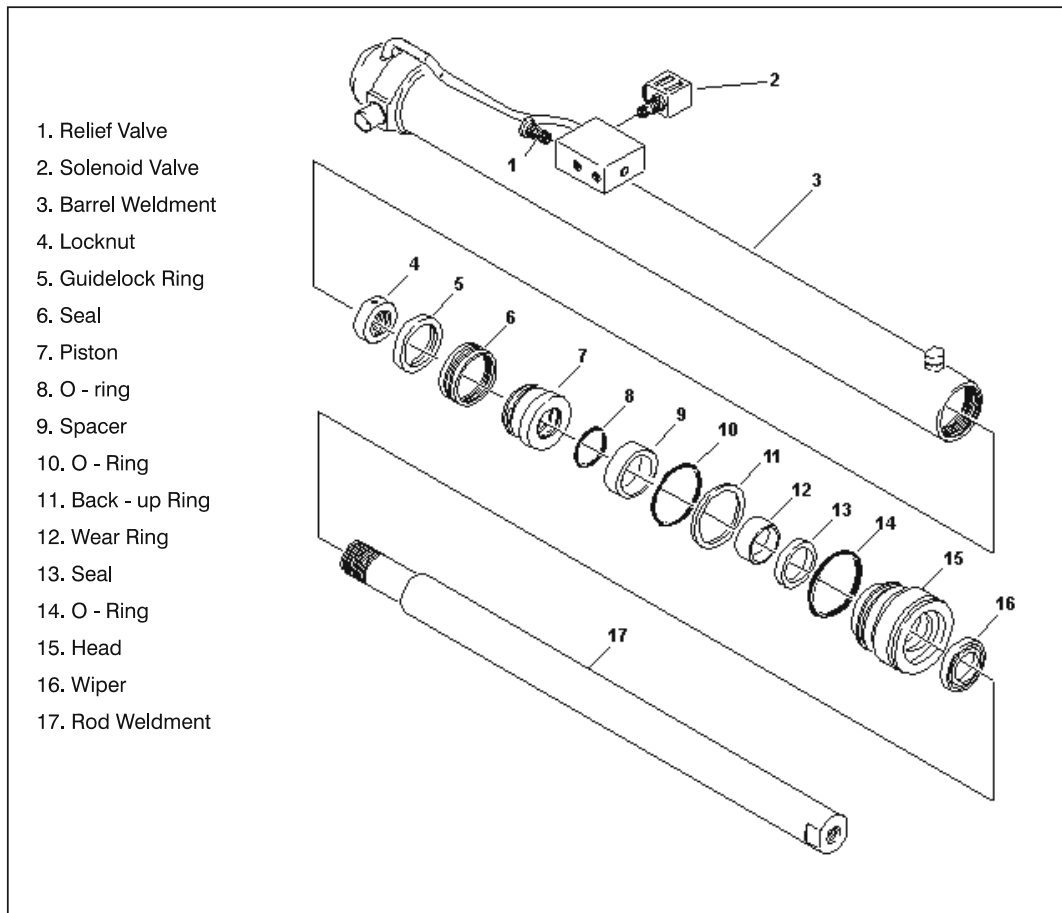

Figure 2-1. Lift Cylinder Assembly

- Place the cylinder barrel into a suitable holding fixture

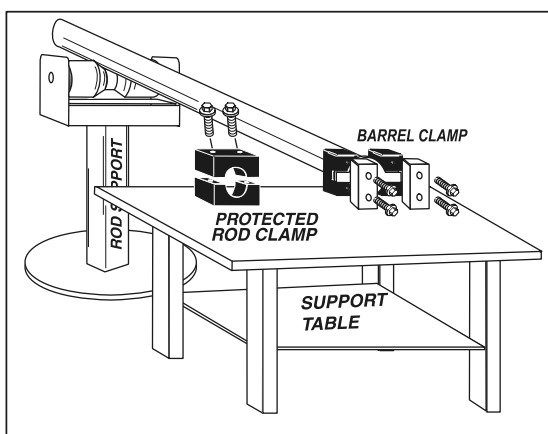

Figure 2-2. Barrel Support

- If applicable, using a suitable spanner wrench, loosen the spanner nut retainer and remove the spanner nut from the cylinder barrel.
- Secure a pull bar to the rod end with a 0.75 - 16 cap-screw fastener.

⚠ IMPORTANT

EXTREME CARE SHOULD BE TAKEN WHEN REMOVING THE CYLINDER ROD, HEAD, AND PISTON. AVOID PULLING THE ROD OFF-CENTER, WHICH COULD CAUSE DAMAGE TO THE PISTON AND CYLINDER BARREL SURFACES.

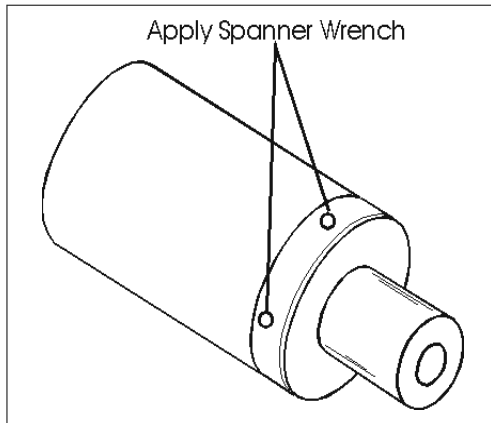

Figure 2-3. Capscrew Removal

7. Using this as a handle, pull out the piston rod and extend until the piston bottoms out on the head
8. Gently tap the piston against the head to drive the rod assembly out.
9. Place the rod on a clean surface that will not damage the chrome.
10. Vise - up on the wrench flats on the end of the rod and remove the piston locknut.

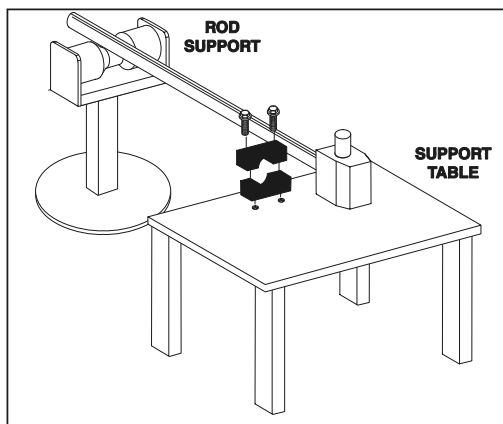

Figure 2-4. Rod Support

11. Break the piston free and separate from the rod.
12. Slide the spacer and head off the rod from the piston shoulder end.

Cleaning and Inspection

1. Clean all parts thoroughly in an approved cleaning solvent.
2. Inspect the cylinder rod for scoring, tapering, ovality, or other damage. There should be no scratches or pits deep enough to catch the fingernail. Pits or scratches that go to the base metal are unacceptable. Chrome should be present over the entire sur-

face of the rod. In the event that an unacceptable condition occurs, the rod should be repaired or replaced.

3. Visually inspect the inside bore of the head for scratches or polishing. Deep scratches are unacceptable. If polishing occurs the bore should be checked for ovality.
4. If ovality occurs it is unacceptable. Check the condition of the seals looking particularly for metal particles embedded in the seal surface.
5. Damage to the seal grooves is unacceptable, particularly on the sealing surfaces. In the event that an unacceptable condition occurs, the piston should be replaced.
6. Visually inspect the bore on the inside tube assembly for pits and scratches. There should be no scratches or pits deep enough to catch the fingernail.
7. Inspect threaded portion of barrel for damage. Dress threads as necessary.
8. Inspect threaded portion of piston for damage. dress threads as necessary.
9. Inspect seal and o-ring grooves in piston for burrs and sharp edges. Dress applicable surfaces as necessary.
10. Inspect threaded portion of head for damage. Dress threads as necessary.
11. Inspect seal and o-ring grooves in head for burrs and sharp edges. Dress applicable surfaces as necessary.
12. Inspect cylinder head outside diameter for scoring or other damage and ovality and tapering. Replace as necessary.
13. Inspect spacer for burrs and sharp edges. If necessary, dress inside diameter surface with Scotch Brite or equivalent.
14. If applicable, inspect port block fittings and holding valve. Replace as necessary.
15. Inspect the oil ports for blockage or the presence of dirt or other foreign material. Repair as necessary.
16. If applicable, inspect piston rings for cracks or other damage. Replace as necessary.

Assembly

NOTE: Prior to cylinder assembly, ensure that the proper cylinder seal kit is used.

Apply a light film of hydraulic oil to all components prior to assembly.

SECTION 2 - PROCEDURES

- Using a special tool, pictured in the following illustration, install a new rod seal into the applicable cylinder head gland groove.

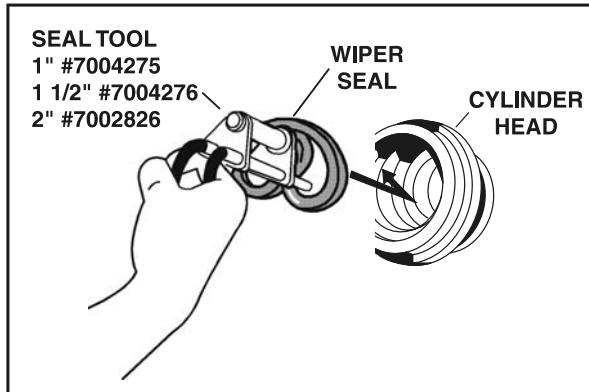

Figure 2-5. Rod Seal Installation

⚠ IMPORTANT

WHEN INSTALLING NEW "PARKER" TYPE PISTON SEALS, ENSURE SEALS ARE INSTALLED PROPERLY. IMPROPER SEAL INSTALLATION COULD RESULT IN CYLINDER LEAKAGE AND IMPROPER CYLINDER OPERATION.

- Using a soft mallet, tap a new wiper seal into the applicable cylinder head gland groove. Install a new wear ring into the applicable head gland groove.
- Place a new o-ring and back-up seal in the applicable outside diameter groove of the cylinder head.
- Install a washer ring onto the rod, then carefully install the head gland on the rod, ensuring that the wiper and rod seals are not damaged or dislodged. Push the head along the rod to the rod end, as applicable.
- Carefully slide the piston spacer onto the rod.
- If applicable, correctly place a new o-ring and back-up rings in the inner piston diameter groove.
- Using suitable protection, clamp the cylinder rod in a vise or similar holding fixture as close to the piston as possible.
- Carefully place the piston on the cylinder rod hand tight, ensuring that the o-ring and back-up rings are not damaged or dislodged.
- Place the piston onto the rod until it abuts the spacer end and install the seal and guidelock ring.
- Place the locknut on the end of the cylinder rod and tighten.
- Remove the cylinder rod from the holding fixture.
- Thoroughly rinse the inside of the rod weldment and allow to drain. Wipe with a lint free rag.
- Clean and visually inspect all parts for material defects and contamination.
- Lubricate the head, piston, and all seals with hydraulic fluid prior to installation.
- When the rod is ready to be installed in the rod weldment, liberally apply an anti-seize lubricant.
- Cover the entire rod assembly with hydraulic fluid and with the rod weldment positioned in a suitable holding fixture insert the rod into the rod weldment.
- Using a spanner wrench tighten the cylinder head.
- After the cylinder has been reassembled, the rod should be pushed all the way in (fully retracted) prior to the reinstallation of any holding valve or valves.
- If applicable, install the cartridge-type holding valve and fittings in the port block using new o-rings as applicable. For proper holding valve torque specifications refer to Table 2-2, Holding Valve Torque Specifications.

⚠ IMPORTANT

EXTREME CARE SHOULD BE TAKEN WHEN INSTALLING THE CYLINDER ROD, HEAD, AND PISTON. AVOID PULLING THE ROD OFF-CENTER, WHICH COULD CAUSE DAMAGE TO THE PISTON AND CYLINDER BARREL SURFACES.

Table 2-1. Cylinder Component Torque Specifications.

Component	Torque Value (w/Loctite)
Piston Nut - Lift Cylinder - 1932E2	375-450 ft lb (508-610 Nm)
Piston Nut - Lift Cylinder - 2032E2/ 2646E2/3246E2	800-1000 ft lb (1085-1356 Nm)

Table 2-2. Holding Valve Torque Specifications.

Description	Torque Value
1932E2, 2032E2 - Hydraforce - 1.25" hex 3/4 - 16 thds	20 ft lb (27.1 Nm)
2646E2/3246E2 - Hydraforce - 1" hex 7/8 - 14 thds	25 ft lb (33.9Nm)

2.11 BRAKE CYLINDER REPAIR

Disassembly

⚠ IMPORTANT

DISASSEMBLY OF THE CYLINDER SHOULD BE PERFORMED ON A CLEAN WORK SURFACE IN A DIRT FREE WORK AREA.

1. Tag and disconnect the hoses from the cylinder ports.

⚠ WARNING

DO NOT FULLY EXTEND CYLINDER TO END OF STROKE. RETRACT CYLINDER SLIGHTLY TO AVOID TRAPPING PRESSURE.

2. Place the cylinder barrel into a suitable holding fixture.
3. Using a suitable pair of snap ring pliers, carefully remove the retaining ring from the cylinder barrel.
4. Attach a suitable pulling device to the cylinder rod end.

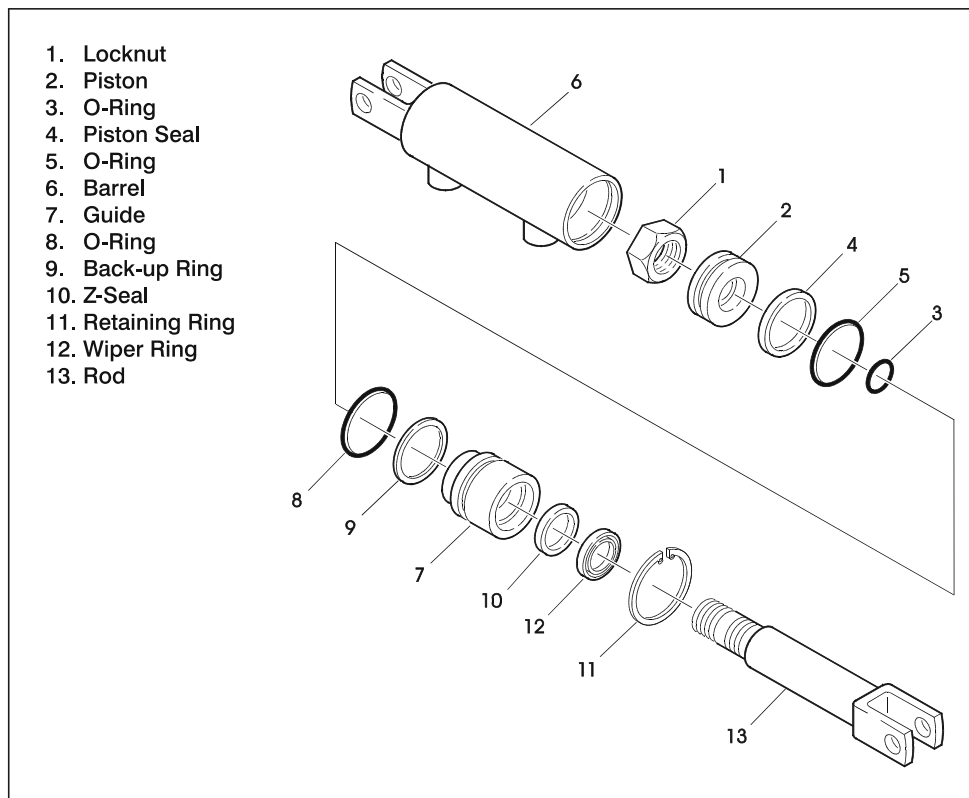

Figure 2-7. Brake Cylinder Assembly

⚠ IMPORTANT

EXTREME CARE SHOULD BE TAKEN WHEN REMOVING THE CYLINDER ROD, GUIDE, AND PISTON. AVOID PULLING THE ROD OFF-CENTER, WHICH COULD CAUSE DAMAGE TO THE PISTON AND CYLINDER BARREL SURFACES.

5. With the barrel clamped securely, apply pressure to the rod pulling device and carefully withdraw the complete rod assembly from the cylinder barrel.
6. Using suitable protection, clamp the cylinder rod in a vise or similar holding fixture.

7. Carefully remove the piston locknut and piston from the cylinder rod. Remove and discard the piston ring and o-rings.
8. Carefully remove the guide from the cylinder rod. Remove and discard the o-ring, back-up ring, rod seal, and wiper ring.
9. Remove the cylinder rod from the holding fixture.

Cleaning and Inspection

1. Clean all parts thoroughly in an approved cleaning solvent.
2. Inspect the cylinder rod for scoring, tapering, ovality, or other damage. If necessary, dress rod with Scotch Brite or equivalent. Replace rod if necessary.
3. Inspect threaded portion of rod for excessive damage. Dress threads as necessary.
4. Inspect inner surface of cylinder barrel tube for scoring or other damage. Check inside diameter for tapering or ovality. Replace if necessary.
5. Inspect piston surface for damage and scoring and for distortion. Dress piston surface or replace piston as necessary.
6. Inspect seal and o-ring grooves in piston for burrs and sharp edges. Dress applicable surfaces as necessary.
7. Inspect cylinder guide inside diameter for scoring or other damage and for ovality and tapering. Replace as necessary.
8. Inspect seal and o-ring grooves in guide for burrs and sharp edges. Dress applicable surfaces as necessary.
9. Inspect cylinder guide outside diameter for scoring or other damage and ovality and tapering. Replace as necessary.
10. Inspect the oil ports for blockage or the presence of dirt or other foreign material. Repair as necessary.

Assembly

NOTE: Prior to cylinder assembly, ensure that the proper cylinder seal kit is used.

Apply a light film of hydraulic oil to all components prior to assembly.

1. Using suitable protection, clamp the cylinder rod in a vise or similar holding fixture.
2. Place a new wiper ring, rod seal, o-ring, and back-up ring into the applicable cylinder guide grooves.
3. Carefully install the guide on the rod, ensuring that the wiper ring and rod seal are not damaged or dislodged. Push the guide onto the rod.
4. Place a new piston ring and o-rings on the piston.
5. Carefully place the piston on the threaded end of the cylinder rod, ensuring that the o-ring is not damaged or dislodged. Push the piston onto the rod as far as it will go.

6. Install the piston locknut on the threaded end of the cylinder rod and torque to 136-163 Nm.
7. Remove the cylinder rod from the holding fixture.
8. Position the cylinder barrel in a suitable holding fixture.

DANGER

EXTREME CARE SHOULD BE TAKEN WHEN INSTALLING THE CYLINDER ROD, GUIDE, AND PISTON. AVOID PULLING THE ROD OFF-CENTER, WHICH COULD CAUSE DAMAGE TO THE PISTON AND CYLINDER BARREL SURFACES.

9. With the barrel clamped securely, and while adequately supporting the cylinder rod, insert the piston end of the rod into the cylinder barrel. Ensure that the piston ring and o-ring are not damaged or dislodged.
10. Continue pushing the rod into the barrel until the cylinder guide can be inserted into the cylinder barrel.
11. Using all applicable safety precautions, secure the cylinder rod assembly with a new retaining ring.
12. Reconnect the hydraulic hoses to the applicable cylinder ports.

2.12 STEER CYLINDER REPAIR

Disassembly

IMPORTANT

DISASSEMBLY OF THE CYLINDER SHOULD BE PERFORMED ON A CLEAN WORK SURFACE IN A DIRT FREE WORK AREA. TAG AND DISCONNECT THE HOSES FROM THE CYLINDER PORTS.

WARNING

DO NOT FULLY EXTEND CYLINDER TO END OF STROKE. RETRACT CYLINDER SLIGHTLY TO AVOID TRAPPING PRESURE.

1. Place the cylinder barrel into a suitable holding fixture.
2. Using a suitable hammer, tap around the outside of the cylinder barrel and guide to shatter the Loctite.
3. Using a suitable spanner wrench, carefully remove the guide from the rod clevis end of the cylinder barrel.
4. Attach a suitable pulling device to the clevis end of cylinder rod section one.

⚠ IMPORTANT

EXTREME CARE SHOULD BE TAKEN WHEN REMOVING THE CYLINDER ROD, GUIDE, AND PISTON. AVOID PULLING THE ROD OFF-CENTER, WHICH COULD CAUSE DAMAGE TO THE PISTON AND CYLINDER BARREL SURFACES.

5. With the barrel clamped securely, apply pressure to the rod pulling device and carefully withdraw the complete rod assembly from the cylinder barrel.
6. Using a suitable hammer, tap around the outside of the cylinder barrel and guide to shatter the Loctite.
7. Using a suitable spanner wrench, carefully remove the remaining guide from the cylinder barrel. Remove and discard the wiper ring, rod seal, back-up ring and o-ring.
8. Using suitable protection, clamp cylinder rod section two in a vise or similar holding fixture.
9. Carefully remove cylinder rod section one from cylinder rod section two and carefully remove the piston from the cylinder rod. Remove and discard the piston seal and o-ring.

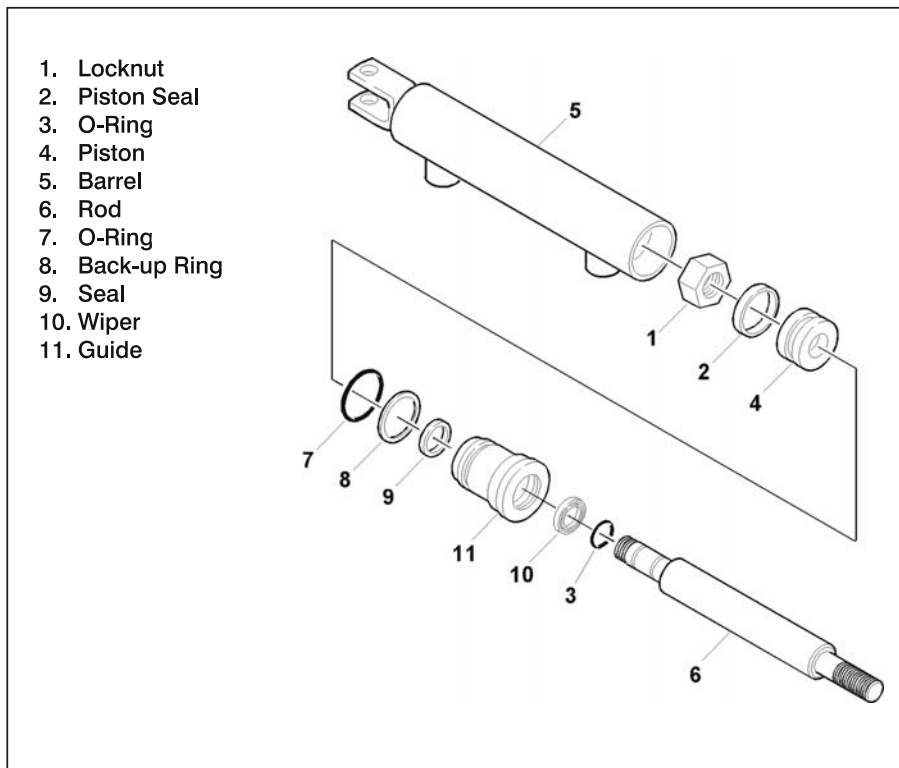

Figure 2-8. Steer Cylinder Assembly

10. Carefully remove the guide from cylinder rod section one. Remove and discard the o-ring, back-up ring, rod seal, and wiper ring.
 11. Remove the cylinder rod from the holding fixture.
- Cleaning and Inspection**
1. Clean all parts thoroughly in an approved cleaning solvent.
 2. Inspect the cylinder rod for scoring, tapering, ovality, or other damage. If necessary, dress rod with Scotch Brite or equivalent. Replace rod if necessary.
 3. Inspect threaded portion of rod for excessive damage. Dress threads as necessary.
 4. Inspect inner surface of cylinder barrel tube for scoring or other damage. Check inside diameter for tapering or ovality. Replace if necessary.
 5. Inspect piston surface for damage and scoring and for distortion. Dress piston surface or replace piston as necessary.
 6. Inspect seal and o-ring grooves in piston for burrs and sharp edges. Dress applicable surfaces as necessary.
 7. Inspect cylinder guide inside diameter for scoring or other damage and for ovality and tapering. Replace as necessary.

SECTION 2 - PROCEDURES

8. Inspect seal and o-ring grooves in guide for burrs and sharp edges. Dress applicable surfaces as necessary.
9. Inspect cylinder guide outside diameter for scoring or other damage and ovality and tapering. Replace as necessary.
10. Inspect the oil ports for blockage or the presence of dirt or other foreign material. Repair as necessary.

Assembly

NOTE: Prior to cylinder assembly, ensure that the proper cylinder seal kit is used. Refer to the Illustrated Parts Manual.
Apply a light film of hydraulic oil to all components prior to assembly.

1. Using suitable protection, clamp the cylinder rod section one in a vise or similar holding fixture.
2. Place a new wiper ring, rod seal, o-ring, and back-up ring into the cylinder rod guide grooves.
3. Carefully install the cylinder rod guide on rod section one, ensuring that the wiper ring and rod seal are not damaged or dislodged. Push the guide onto the rod section.
4. Place a new piston ring on the piston and a new o-ring on the threaded end of cylinder rod section two.
5. Carefully place the piston on the threaded end of cylinder rod section two, ensuring that the o-ring is not damaged or dislodged. Push the piston onto the rod as far as it will go.
6. Attach cylinder rod section one to the threaded end of cylinder rod section two and assemble.
7. Remove the cylinder rod assembly from the holding fixture.
8. Position the cylinder barrel in a suitable holding fixture.

IMPORTANT

EXTREME CARE SHOULD BE TAKEN WHEN INSTALLING THE CYLINDER ROD, CYLINDER ROD GUIDE, AND PISTON. AVOID PULLING THE ROD OFF-CENTER, WHICH COULD CAUSE DAMAGE TO THE PISTON AND CYLINDER BARREL SURFACES.

9. With the barrel clamped securely, and while adequately supporting the cylinder rod assembly, insert the piston end of the rod assembly into the cylinder barrel. Ensure that the piston ring and o-ring are not damaged or dislodged.

10. Continue pushing the rod into the barrel until the cylinder rod guide can be inserted into the end of the cylinder barrel.
11. Coat the threads of the cylinder rod guide with Loctite #271 then secure the cylinder rod guide to the cylinder barrel using a suitable spanner wrench.
12. On the remaining cylinder rod guide, place a new wiper ring, rod seal, o-ring, and back-up ring into the cylinder rod guide grooves.
13. Carefully install the cylinder rod guide onto rod section two and slide the guide into the end of the cylinder barrel.
14. Coat the threads of the cylinder rod guide with Loctite #271 then secure the cylinder rod guide to the cylinder barrel using a suitable spanner wrench.
15. Reconnect the hydraulic hoses to the applicable cylinder ports.

2.13 TILT SWITCH ADJUSTMENT

NOTE: The machine may be equipped with a tilt switch (sensor), factory set to activate when the machine is elevated and out of level in any direction at 1.5° on the 1932E2/2032E2 and 2° on the 2632E2/2646E2/3246E2. When this occurs the drive function is cut out. Consult factory for tilt sensor adjustment. The only field adjustment necessary is leveling the switch on the spring loaded studs. There are two methods of adjustment, a manual adjustment and an adjustment using a voltmeter.

CAUTION

PERFORM TILT ALARM SWITCH LEVELING PROCEDURE A MINIMUM OF EVERY SIX MONTHS TO ENSURE PROPER OPERATION AND ADJUSTMENT OF SWITCH.

Manual Adjustment

1. Park the machine on a flat, level surface and ensure the machine is level.

NOTE: Ensure switch mounting bracket is level and securely attached.

2. Level the base of the indicator by tightening the three flange nuts. Tighten each nut through approximately one half of its spring travel. **DO NOT ADJUST THE (X) NUT DURING THE REMAINDER OF THE PROCEDURE.**
3. With the electrical connections complete, slowly tighten one of the (Y) nuts until the circuit is closed (the light on the Platform Control Console illuminates, the tilt alarm sounds).

4. Slowly back off the nut, counting the number of turns, until the circuit is closed again
5. Divide the number of turns determined in step 4 in half. Tighten the nut this many turns. The line determined by this nut and the (X) nut is now parallel to the ground.
6. Repeat steps 3 through 5 for the remaining (Y) nut. The switch is now level.

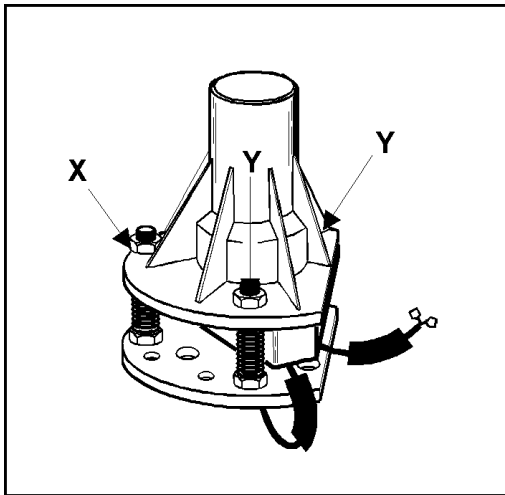

Figure 2-9. Tilt Switch Leveling Manual Adjustment

7. Divide the number of turns determined in step 4 in half. Tighten the nut this many turns. The line determined by this nut and the (X) nut is now parallel to the ground.
8. Repeat steps 3 through 5 for the remaining (Y) nut. The switch is now level.
9. Individually push down on one corner at a time; there should be enough travel to cause the switch to trip. If the switch does not trip in all three tests, the flange nuts have been tightened too far. Loosen the (X) nut and repeat steps 3 through 7.

Voltmeter Adjustment

1. Park the machine on a flat, level surface and ensure the machine is level.
2. If the motor is not running, turn the ignition switch to ON.
3. Connect the black lead of the voltmeter to ground and the red lead to the yellow wire protruding from the pot on the bottom of the sensor.
4. Adjust the leveling nuts to obtain the highest possible voltage reading.
5. Check the voltage at the trip point in all four directions. If the voltage reading is not symmetrical, repeat step 4 above.

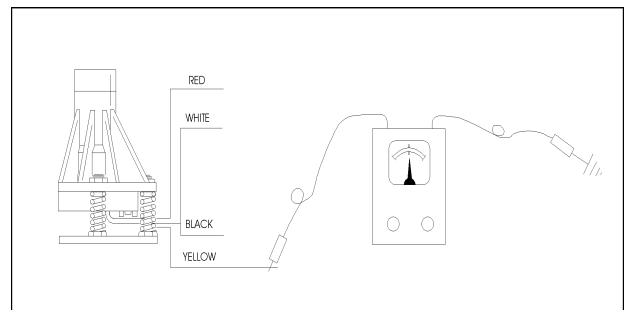

Figure 2-10. Tilt Switch Leveling Voltmeter Adjustment

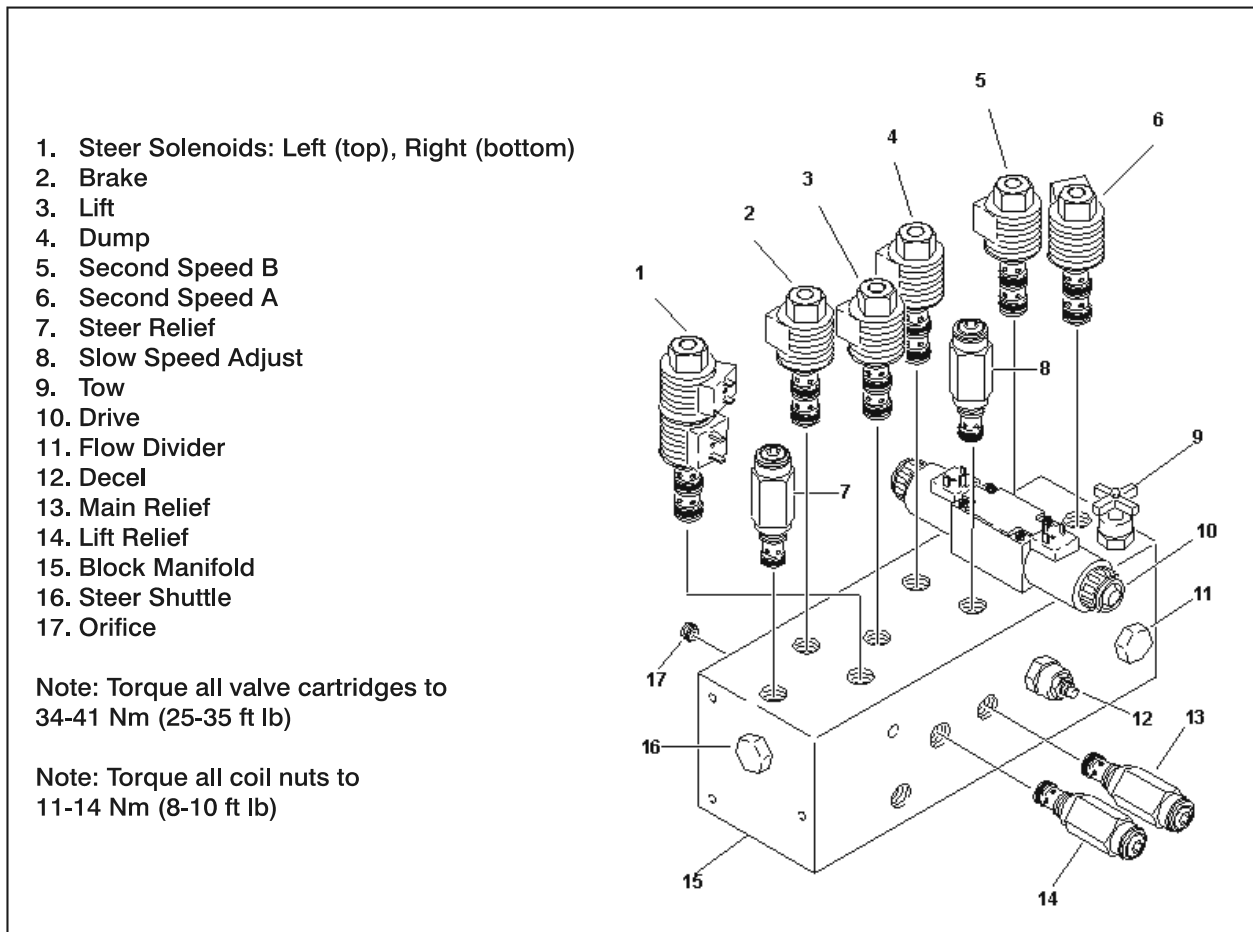

Figure 2-11. Control Valve Components

1. Steer Solenoids: Left (top), Right (bottom)
2. Brake
3. Lift
4. Dump
5. Second Speed B
6. Second Speed A
7. Steer Relief
8. Slow Speed Adjust
9. Tow
10. Drive
11. Flow Divider
12. Decel
13. Main Relief
14. Lift Relief
15. Block Manifold
16. Steer Shuttle
17. Orifice

Note: Torque all valve cartridges to 34-41 Nm (25-35 ft lb)

Note: Torque all coil nuts to 11-14 Nm (8-10 ft lb)

2.14 PRESSURE SETTING PROCEDURES

NOTE: Make all pressure adjustments with motor operating and hydraulic oil at normal operating temperature. In addition, all functions must be operated from the platform control station in order to achieve full pump speed. It may be necessary to use an assistant to adjust the pressure settings while operating the functions from the platform control station.

Lift Relief for Non Proportional Control Machines

1. Install a pressure gauge at gauge port MP, located at the inside top of the valve body. The port is identified by a stamping on the valve body.
2. Disconnect the hose from valve port 3, then plug the hose and the valve port.

3. From the platform control station, activate the Lift Up function by pressing the LIFT switch and activating the controller to the full forward position.
4. Adjust Lift Relief to value in the Pressure Settings Chart.
5. Shut down hydraulic system and remove pressure gauge.

Steer Adjustment for Non Proportional Control Machines

1. With pressure gauge at "MP" port on control valve activate steer in either direction.
2. Adjust Steer Relief to value in the Pressure Settings Chart

Main Relief Pressure Switch for Non Proportional Control Machines

1. Install a pressure gauge at gauge port MP, located at the bottom front of the valve body. The port is identified by a stamping on the valve body.
2. Disconnect the power from the drive valve on top of the valve body.
3. Activate drive by moving the joystick to the full forward position.
4. Adjust Main Relief to value in the pressure setting chart.
5. Reinstall the electrical connections to the drive valve.

Lift Relief Adjustments for Proportional Control Machines

1. Install a pressure gauge at gauge port MP, located at the inside top of the valve body. The port is identified by a stamping on the valve body.
2. Disconnect the hose from valve port 3, then plug the hose and the valve port.
3. From the platform control station, activate the Lift Up function by pressing the LIFT switch and activating the controller to the full forward position.
4. Adjust Lift Relief to value in the Pressure Settings Chart.
5. Shut down hydraulic system and remove pressure gauge.

Steer Adjustment for Proportional Control Machines

1. With pressure gauge at "MP" port on control valve activate steer in either direction.
2. Activate drive by pressing the drive switch and activating the controller to the full forward position. While holding the controller, activate steer right and check steer right pressure. If necessary, adjust steer right pressure to value in the Pressure Settings Chart.
3. Activate drive by pressing the drive switch and activating the controller to the full forward position. While holding the controller, activate steer left and check steer left pressure. If necessary, adjust steer left pressure to value in the Pressure Settings Chart.

Main Relief and High Drive Pressure Switch for Proportional Control Machines

1. Install a pressure gauge at gauge port MP, located at the bottom front of the valve body. The port is identified by a stamping on the valve body.
2. Close the steer valve completely by turning clockwise.
3. Once the steer valve is closed activate the steer switch in either direction until the steer cylinder bottoms out.
4. Adjust your Main Pressure to value in the Pressure Settings Chart.
5. Once you have adjusted your main pressure be sure and reset your steer pressure back to value in the Pressure Settings Chart.

Table 2-3. Pressure Settings Chart

Function	1932E2		2032E2		2632E2/2646E2/ 3246E2		3246E2 w/Proportional Control	
	psi	bar	psi	bar	psi	bar	psi	bar
Main Relief/High Drive	3200	221	3200	221	3200	221	3000	207
Lift	2300	159	2200	152	2400	165	2100	145
Steer	2000	138	2000	138	2000	138	2100	145

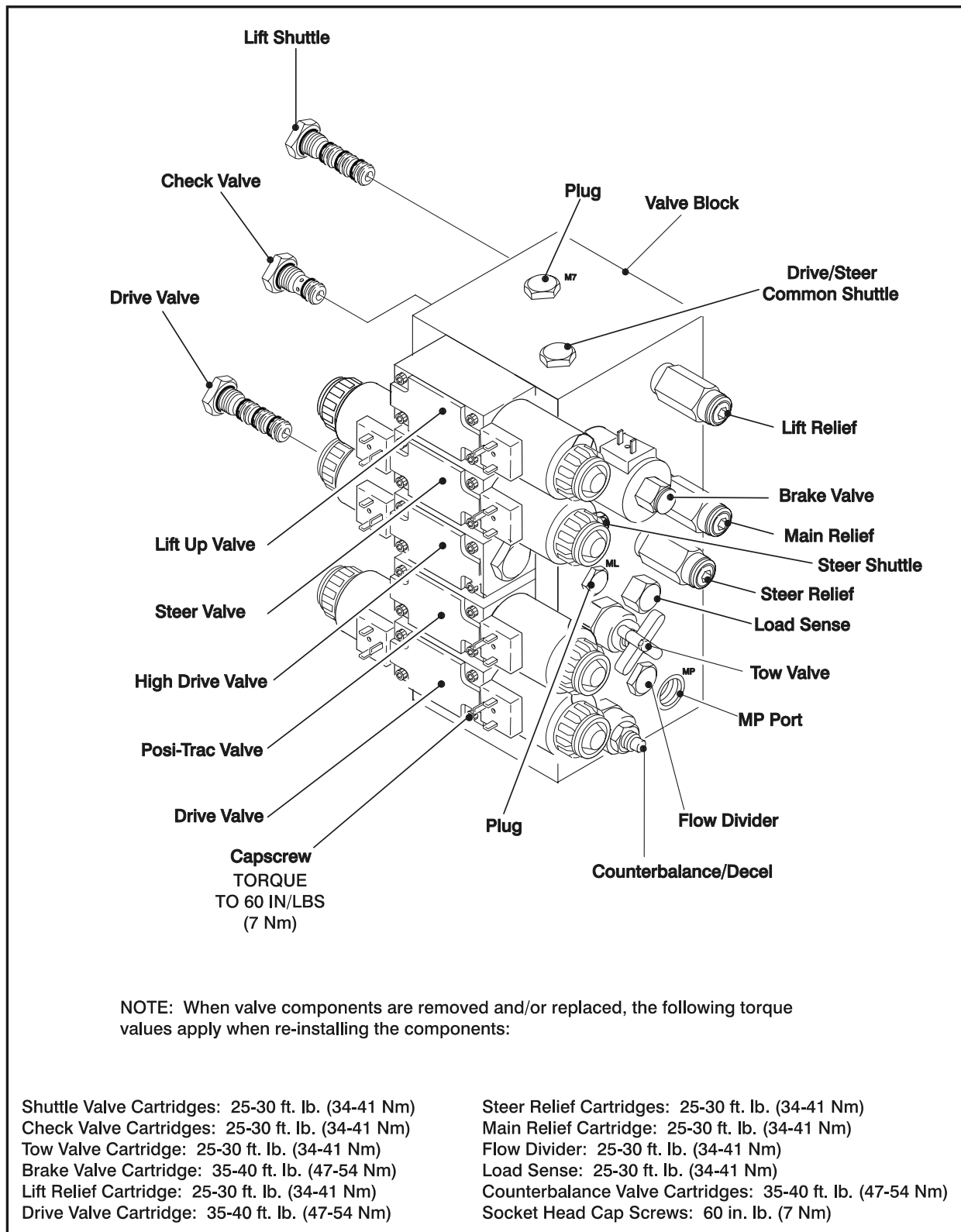

Figure 2-12. Control Valve Components (3246E2 w/Proportional Control)

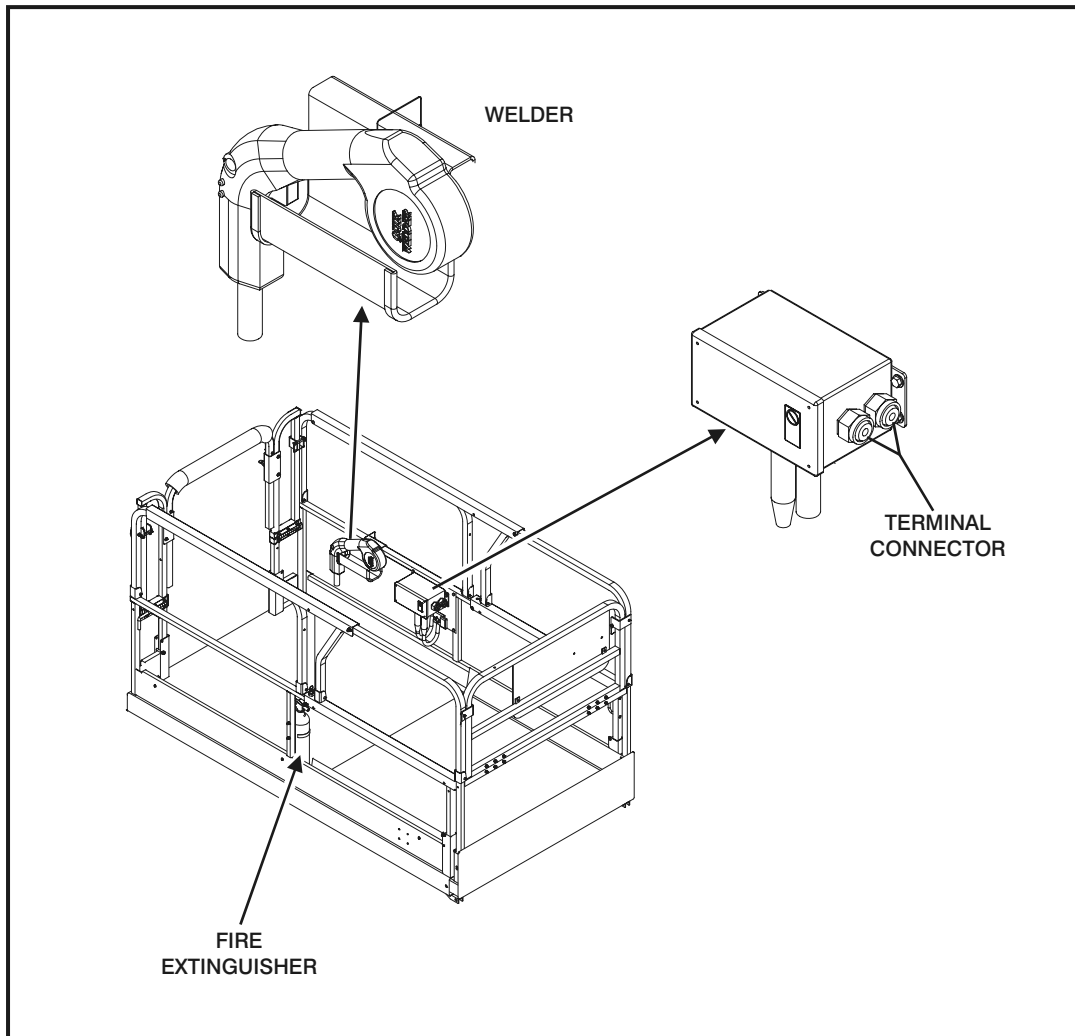

Figure 2-13. Quick Welder™ Installation

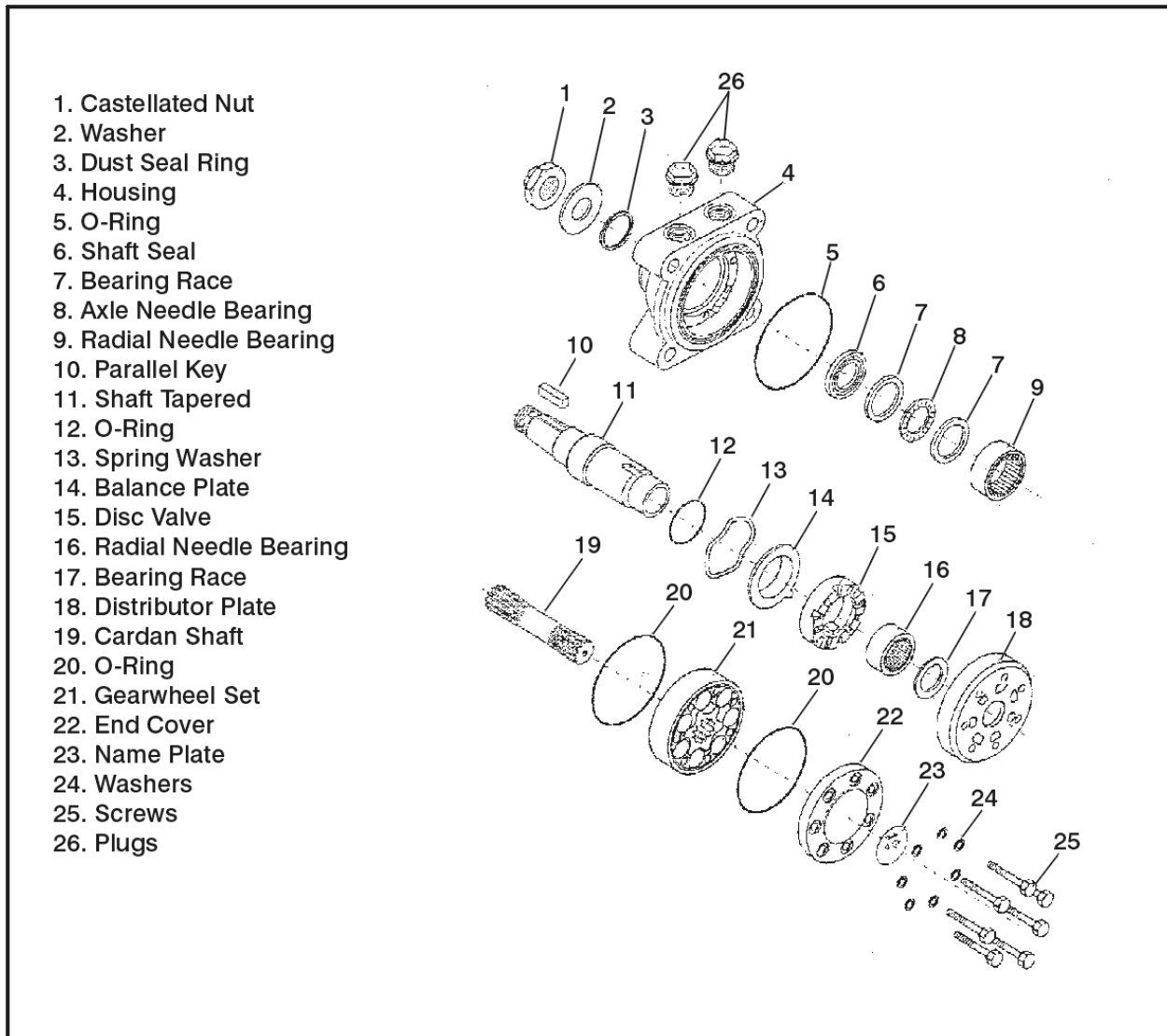

Figure 2-14. Drive Motor (Sauer Danfoss)

2.15 DRIVE MOTOR (SAUER DANFOSS)

Dismantling

1. Place motor in proper holding device that allows access to the output shaft.
2. Carefully remove end cover sideways being sure to catch any parts that may fall from the gearwheel.
3. The needle bearings will fall out during dismantling and can be collected and reused. The outer ring and thrust bearing need not be removed.
4. With the housing in the holding device, press the shaft out of the housing. Collect the needle bearings for possible re-use.
5. Remove the housing from the holding device and place on a workbench. With a screwdriver, gently lever the dust seal ring from the housing.
6. Extract the shaft seal from the housing.
7. Press the remaining parts out using hydraulic equipment.
8. Clean all parts carefully with a low aromatic kerosene.

Assembly

NOTE: Before assembly, inspect all parts and replace if necessary.

Before assembly, lubricate all parts with hydraulic oil and grease rubber parts with Vaseline.

1. Turn motor housing so the rear end faces upwards. Press shaft seal into housing.
2. The bearing race can be fitted in any position.
3. Place the needle bearings in the outer ring and hold them in place with grease. Place the whole bearing into the housing. Press the bearing into position using pressure equipment if necessary.
4. Carefully insert shaft through bearing housing.
5. Place O-ring (greased) in bearing housing O-ring recess.
6. Place spring washer on balance plate, insert O-ring in recess and lubricate with grease. Place balance plate lightly in position so that it engages. Be careful not to damage the O-ring.
7. Place the disc valve on the shaft with channels upwards so that the long tab on the disc valve engages with the slot in the shaft.
8. If there is a difference in the spline length, fit the cardan shaft with the long spline end in the output shaft. Mark the bottom of the cardan spline that lies adjacent to the long tab on the disc valve.
9. Place the needles in the outer ring and hold them in place with grease. Carefully place the distributor plate on the bearing housing so that the shaft enters the bearing. Press the distributor plate until it stops on the housing and line up the screw holes.
10. Place the O-rings (greased) in the gearwheel O-ring recesses. If there is a recess on one end of the splined hole, position the gearwheel with recess on the same side as the smallest screw hole (stage hole) in the gearwheel rim. Fit the gearwheel set with this side facing the motor.
11. Clockwise Revolution:
Fit the gearwheel set on the cardan shaft so that the top of a tooth in the external teeth of the gearwheel is vertically over the mark on the cardan shaft. Turn the gearwheel set counterclockwise until the cardan shaft and gearwheel engage (15°). Turn the gearwheel rim to line up the screw holes.
12. Counterclockwise Revolution:
Fit the gearwheel set on the cardan shaft so that the top of a tooth in the external teeth of the gearwheel is vertically over the mark on the cardan shaft. Turn the gearwheel set clockwise until the cardan shaft

and the gearwheel engage (15°). Turn the gearwheel to line up the screw holes.

13. Rotate the end cover to line up the screw holes.
14. Use new washers and a 13 mm socket spanner. Torque to 330-380 lb in (3.75 - 4.25 daNm).
15. Screw in plastic plugs.
16. Turn the motor over and strike the dust seal into place with a plastic hammer and suitable mandrel.
17. Secure the key in place with tape.

2.16 DRIVE MOTOR (REXROTH)

Disassembly

1. Place the drive motor vertically in a vice with the output shaft pointing downwards.
2. Using a 17mm spanner wrench loosen the 7 cover bolts. remove the cover with the bolts.
3. Lift off the displacer and the intermediate disk.
4. Remove the cardan shaft.
5. Remove the control sleeve.
6. Remove the check valves consisting of ball, limit, stop and filler (filler only when one valve is installed).
7. Turn the drive around in the vise so that the output shaft is facing up. Remove the keyed shaft.
8. Loosen the 8 socket head cap screws on the flange mounting using a 4mm allen wrench.
9. Withdraw the flange from the shaft while holding the flange in a special fixture.
10. Turn the motor around again. Attach a mandrel and press the output shaft with bearing out of the motor housing with the help of a lever press.

Assembly

1. The output shaft with pressed on and adjusted tapered roller bearing and cylindrical shaft is to be centrally positioned onto the housing edge. Press the complete assembly into the housing to the limit stop with the help of the press.

NOTE: Do not jam.

2. Before mounting the flange, put a mounting sleeve onto the shaft.

NOTE: Be sure that the seal is thoroughly oiled.

3. Position the flange with slight pressure into the housing. Take care to avoid damage to the seals.

SECTION 2 - PROCEDURES

4. Screw in the 8 socket head cap screws. Using a Torque wrench, tighten to 80 in lb (8 Nm).
5. After turning the motor around introduce the control sleeve. Make sure that the cylindrical roll of the output shaft clicks into the groove of the control sleeve.
6. Insert the O-ring into the housing.
7. Installation of the check valves:
Insert 2 ball valves and carefully drive them in using a mandrel.
8. Insert the limit stop and put the filler into position for the lower valve.
9. Put the cardan shaft into position. Note that the marked tooth must comply with the marking on the control sleeve.
10. Position the intermediate disk.
11. Insert the O-ring into the recess of the displacer.
12. Place the displacer so that the tooth marking on the cardan shaft on the displacer side meshes with the tooth base of the rotor gearwheel that is located centrally at the lowest point in the outer profile of the rotor gearwheel. This is only possible at 6 positions.
13. Insert O-ring.
14. Insert spacer.
15. Remount cover, tighten the 7 hexagon bolts using a torque wrench (torque to 60Nm 43 ft lb). The output shaft should turn easily.

2.17 DRIVE MOTOR (PARKER)

Disassembly and inspection

1. Place the Torqlink™ in a soft jawed vice, with coupling shaft (12) pointed down and the vise jaws clamping firmly on the sides of the housing (18) mounting flange or port bosses. Remove manifold port O-Rings (18A) if applicable.

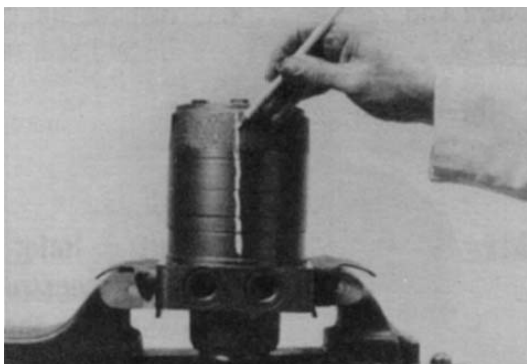

⚠ WARNING

IF THE TORQLINK™ IS NOT FIRMLY HELD IN THE VISE, IT COULD BE DISLODGED DURING THE SERVICE PROCEDURES, CAUSING INJURY.

2. Scribe an alignment mark down and across the Torqlink™ components from end cover (2) to housing (18) to facilitate reassembly orientation where required. Loosen two shuttle or relief valve plugs (21) for disassembly later if included in end cover. 3/16 or 3/8 inch Allen wrench or 1 inch hex socket required.

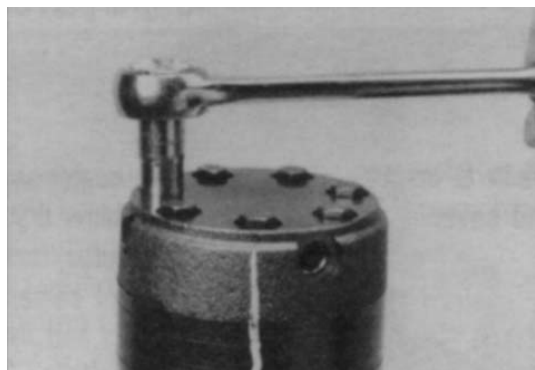
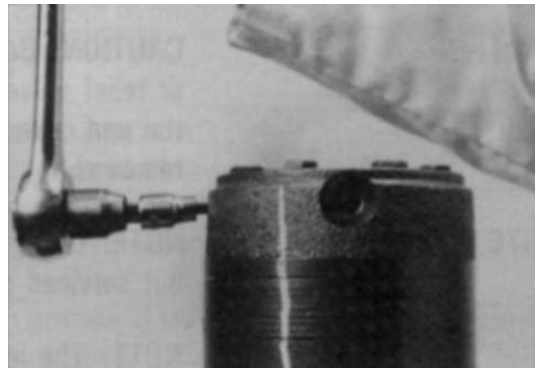

3. Remove the five, six, or seven special ring head bolts (1) using an appropriate 1/2 or 9/16 inch size socket. Inspect bolts for damaged threads, or sealing rings, under the bolt head. Replace damaged bolts

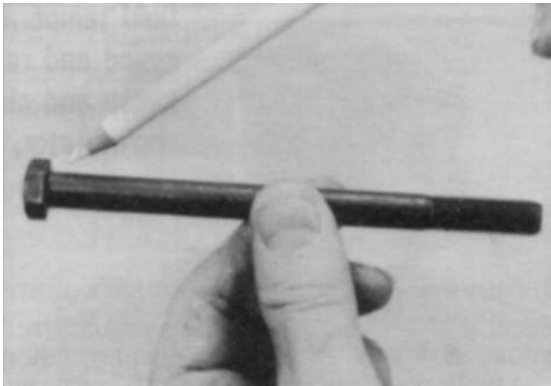

4. Remove end cover assembly (2) and seal ring (4).
Discard seal ring



NOTE: Refer to the appropriate "alternate cover construction" on the exploded view to determine the end cover construction being serviced.

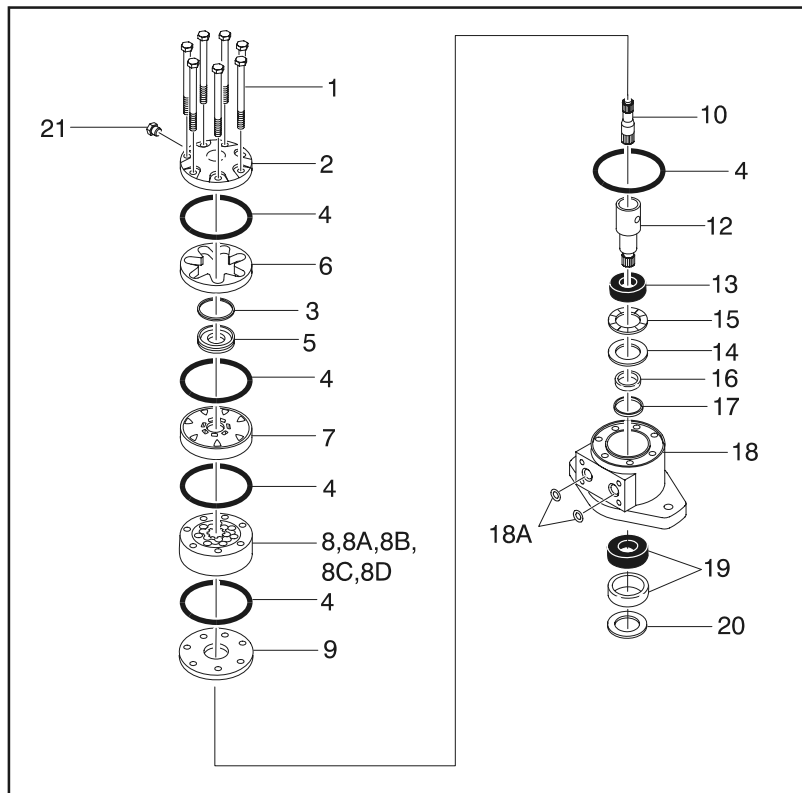

- | | | |
|-------------------------|----------------------------|----------------------------|
| 1. Special Bolts | 8B. Stator or Stator Vane | 16. Seal |
| 2. End Cover | 8C. Vane | 17. Back-up Washer |
| 3. Seal Ring-Commutator | 8D. Stator Half | 18. Housing |
| 4. Seal Ring | 9. Wear Plate | 18A. O-Ring |
| 5. Commutator Ring | 10. Drive Link | 19. Bearing/Bushing, Outer |
| 6. Commutator Ring | 12. Coupling Shaft | 20. Dirt & Water Seal |
| 7. Manifold | 13. Bearing/Bushing, Inner | 21. Plug |
| 8. Rotor Set | 14. Thrust Washer | |
| 8A. Rotor | 15. Thrust Bearing | |

Figure 2-15. Parker Drive Motor

- If the end cover (2) is equipped with shuttle valve components, remove the two previously loosened plugs (21).

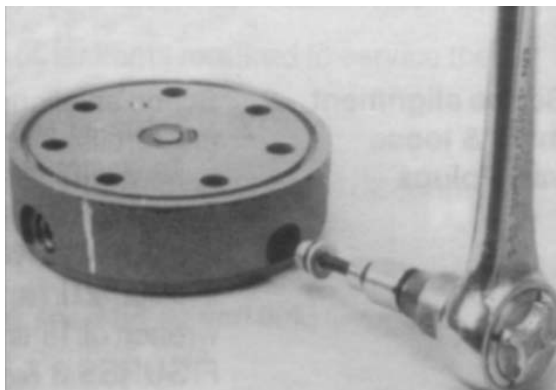

CAUTION

BE READY TO CATCH THE SHUTTLE VALVE OR RELIEF VALVE COMPONENTS THAT WILL FALL OUT OF THE END COVER VALVE CAVITY WHEN THE PLUGS ARE REMOVED.

NOTE: The insert and if included the orifice plug in the end cover (2) must not be removed as they are serviced as an integral part of the end cover.

6. Thoroughly wash end cover (2) in proper solvent and blow dry. Be sure the end cover valve apertures, including the internal orifice plug, are free of contamination. Inspect end cover for cracks and the bolt head recesses for good bolt head sealing surfaces. Replace end cover as necessary.

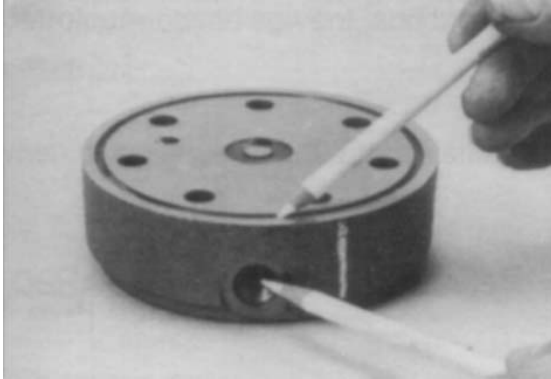

NOTE: A polished pattern (not scratches) on the cover from rotation of the commutator (5) is normal. Discoloration would indicate excess fluid temperature, thermal shock, or excess speed and require system investigation for cause and close inspection of end cover, commutator, manifold, and rotor set.

7. Remove commutator ring (6). Inspect commutator ring for cracks, or burrs.



8. Remove commutator (5) and seal ring (3) Remove seal ring from commutator, using an air hose to blow air into ring groove until seal ring is lifted out and discard seal ring. Inspect commutator for cracks or burrs, wear, scoring, spalling or brinelling. If any of

these conditions exist, replace commutator and commutator ring as a matched set.



9. Remove manifold (7) and inspect for cracks surface scoring, brinelling or spalling. Replace manifold if any of these conditions exist. A polished pattern on the ground surface from commutator or rotor rotation is normal. Remove and discard the seal rings (4) that are on both sides of the manifold.



NOTE: The manifold is constructed of plates bonded together to form an integral component not subject to further disassembly for service. Compare configuration of both sides of the manifold to ensure that same surface is reassembled against the rotor set.

SECTION 2 - PROCEDURES

10. Remove rotor set (8) and warplane (9), together to retain the rotor set in its assembled form, maintaining the same rotor vane (8C) to stator (8B) contact surfaces. The drive link (10) may come away from the coupling shaft (12) with the rotor set, and wearplate. You may have to shift the rotor set on the warplane to work the drive link out of the rotor (8A) and warplane. Inspect the rotor set in its assembled form for nicks, scoring, or spalling on any surface and for broken or worn splines. If the rotor set component requires replacement, the complete rotor set must be replaced as it is a matched set. Inspect the warplane for cracks, brinelling, or scoring. Discard seal ring (4) that is between the rotor set and wearplate.

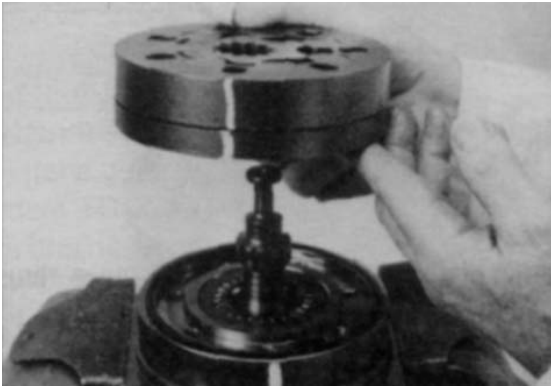

NOTE: The rotor set (8) components may become disassembled during service procedures. Marking the surface of the rotor and stator that is facing UP, with etching ink or grease pencil before removal from Torqlink™ will ensure correct reassembly of rotor into stator and rotor set into Torqlink™. Marking all rotor components and mating spline components for exact repositioning at assembly will ensure maximum wear life and performance of rotor set and Torqlink™.



NOTE: Series TG Torqlinks™ may have a rotor set with two stator halves (8B) with a seal ring (4) between them and two sets of seven vanes (8C). Discard seal ring only if stator halves become disassembled during the service procedures.

NOTE: A polished pattern on the wear plate from rotor rotation is normal.

11. Place rotor set (8) and wear plate (9) on a flat surface and center rotor (8A) in stator (8B) such that two rotor lobes (180 degrees apart) and a roller vane (8C) centerline are on the same stator centerline. Check the rotor lobe to roller vane clearance with a feeler gage at this common centerline. If there is more than 0.005 inches (0.13 mm) of clearance, replace rotor set.

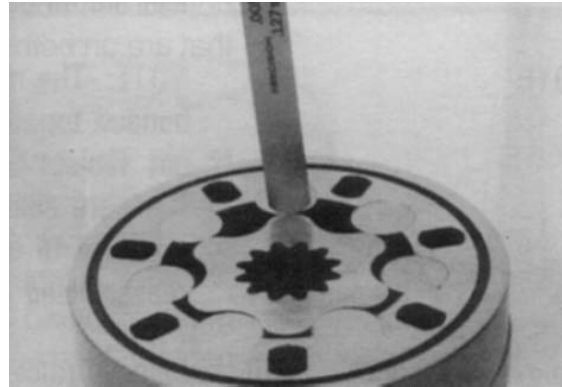

NOTE: If rotor set (8) has two stator halves (8B & 8D) and two sets of seven vanes (8C & 8E) as shown in the alternate construction TG rotor set assembly view, check the rotor lobe to roller vane clearance at both ends of rotor.

12. Remove drive link (10) from coupling shaft (12) if it was not removed with rotor set and wear plate. Inspect drive link for cracks and worn or damaged splines. No perceptible lash (play) should be noted between mating spline parts. Remove and discard seal ring (4) from housing (18).



13. Remove thrust bearing (11) from top of coupling shaft (12). Inspect for wear, brinelling, corrosion and a full complement of retained rollers.

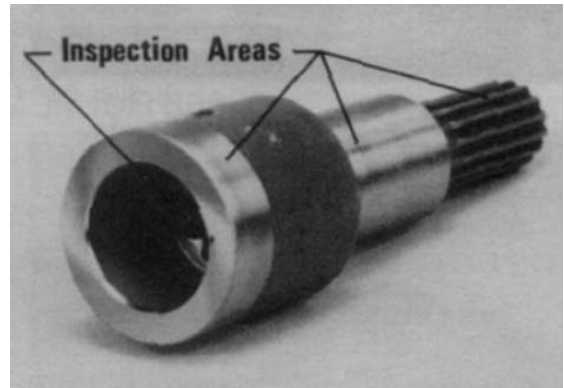

NOTE: Minor shaft wear in seal area is permissible. If wear exceeds 0.020 inches (0.51 mm) diametrically, replace coupling shaft.

14. Check exposed portion of coupling shaft (12) to be sure you have removed all signs of rust and corrosion which might prevent its withdrawal through the seal and bearing. Crocus cloth or fine emery paper may be used

NOTE: A slight "polish" is permissible in the shaft bearing areas. Anything more would require coupling shaft replacement.

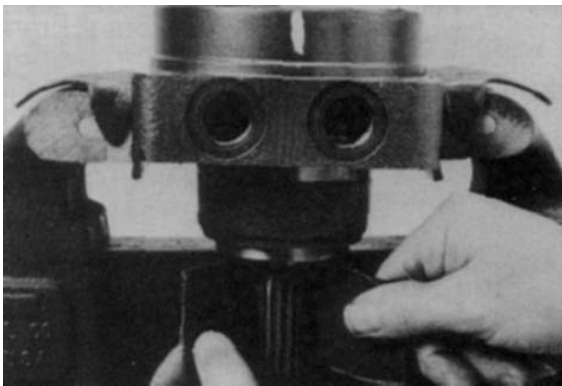

16. Remove and discard seal ring (4) from housing (18).

17. Remove thrust bearing (15) and thrust washer (14) Inspect for wear, brinelling, corrosion and a full complement of retained rollers.

15. Remove coupling shaft (12), by pushing on the output end of shaft. Inspect coupling shaft bearing and seal surfaces for spalling, nicks, grooves, severe wear or corrosion and discoloration. Inspect for damaged or worn internal and external splines or keyway. Replace coupling shaft if any of these conditions exist.

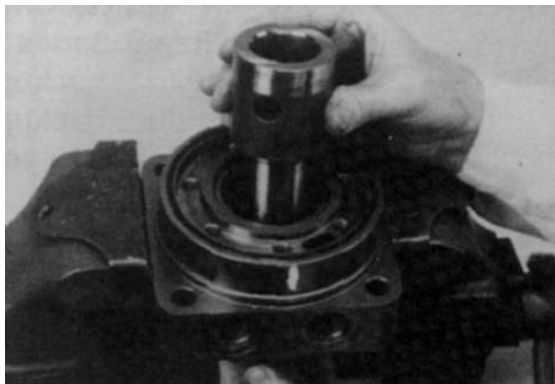

18. Remove seal (16) and back up washer (17) from Small Frame, housing (18). Discard both.



SECTION 2 - PROCEDURES

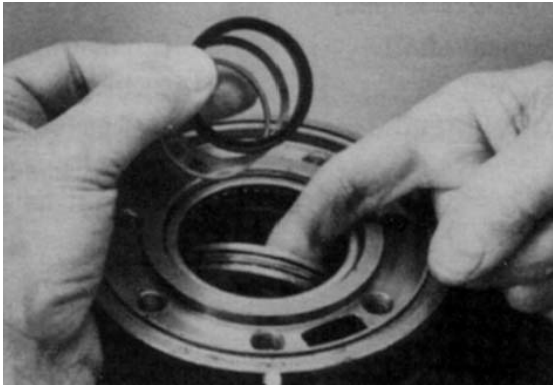

19. Remove housing (18) from vise, invert it and remove and discard seal (20). A blind hole bearing or seal puller is required.

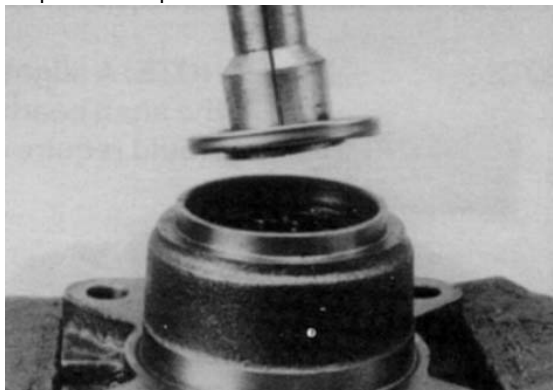

20. Inspect housing (18) assembly for cracks, the machined surfaces for nicks, burrs, brinelling or corrosion. Remove burrs that can be removed without changing dimensional characteristics. Inspect tapped holes for thread damage. If the housing is defective in these areas, discard the housing assembly.

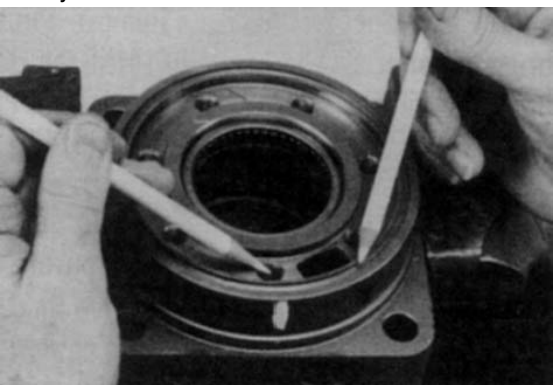

21. If the housing (18) assembly has passed inspection to this point, inspect the housing bearings/bushings (19) and (13) and if they are captured in the housing cavity the two thrust washers (14) and thrust bearing (15). The bearing rollers must be firmly retained in the bearing cages, but must rotate and orbit freely. All rollers and thrust washers must be free of brinelling and corrosion. The bushing (19) or (13) to coupling shaft diameter clearance must not exceed 0.010 inch (0.025 mm). A bearing, bushing, or thrust washer that does not pass inspection must be replaced. If the housing has passed this inspection the disassembly of the Torqlink™ is completed.

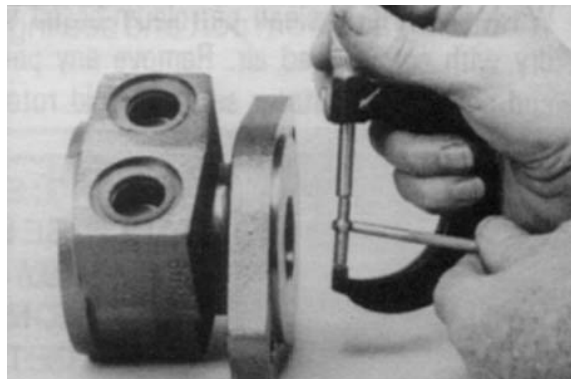
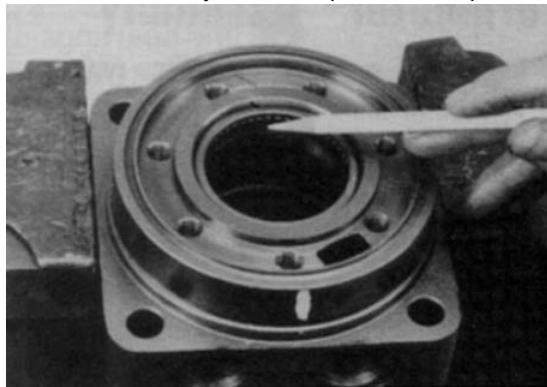

NOTE: The depth or location of bearing/bushing (13) in relation to the housing wear plate surface and the depth or location of bearing/bushing (19) in relation to the beginning of bearing/bushing counter bore should be measured and noted before removing the bearings/bushings. This will facilitate the correct reassembly of new bearings/bushings.

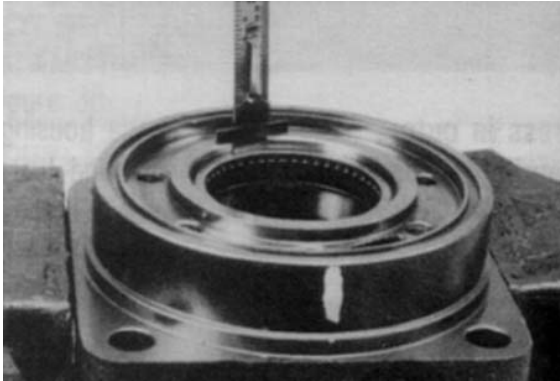

22. If the bearings, bushing or thrust washers must be replaced use a suitable size bearing puller to remove bearing/bushings (19) and (13) from housing (18) without damaging the housing. Remove thrust washers (14) and thrust bearing (15) if they were previously retained in the housing by bearing (13).

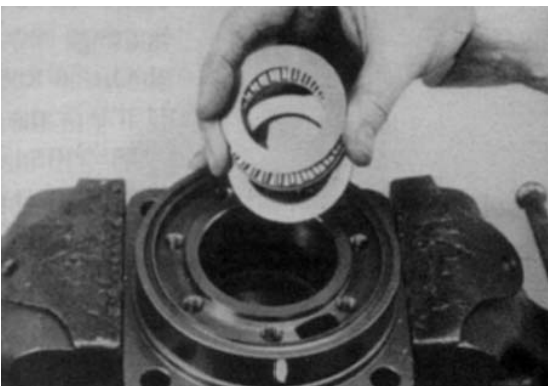
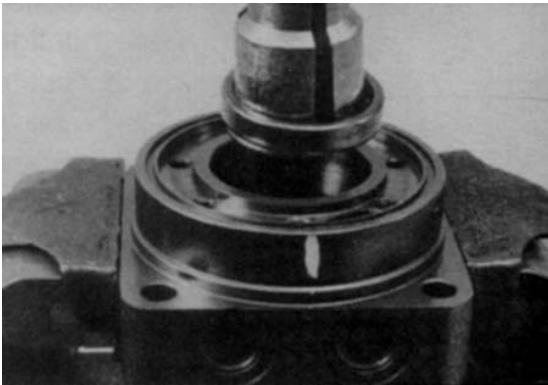

Assembly

Replace all seals and seal rings with new ones each time you reassemble the Torqlink™ unit. Lubricate all seals and seal rings with SAE 10W40 oil or clean grease before assembly.

NOTE: Individual seals and seal rings as well as a complete seal kit are available. The parts should be available through most OEM parts distributors or Parker approved Torqlink™ distributors. (Contact your local dealer for availability).

NOTE: Unless otherwise indicated, do not oil or grease parts before assembly.

Wash all parts in clean petroleum-based solvents before assembly. Blow them dry with compressed air. Remove any paint chips from mating surfaces of the end cover, commutator set, manifold rotor set, wear plate and housing and from port and sealing areas.

⚠ WARNING

SINCE THEY ARE FLAMMABLE, BE EXTREMELY CAREFUL WHEN USING ANY SOLVENT. EVEN A SMALL EXPLOSION OR FIRE COULD CAUSE INJURY OR DEATH.

⚠ WARNING

WEAR EYE PROTECTION AND BE SURE TO COMPLY WITH OSHA OR OTHER MAXIMUM AIR PRESSURE REQUIREMENTS.

1. If the housing (18) bearing components were removed for replacement, thoroughly coat and pack a **new** outer bearing/bushing (19) with clean corrosion resistant grease recommended in the material section. Press the new bearing/bushing into the counterbore at the mounting flange end of the housing, using the appropriate sized bearing mandrel, which will control the bearing/ bushing depth.

Torqlink™ housings require the use of bearing mandrel to press bearing/ bushing (19) into the housing to a required depth of 0.151/0.161 inches (3.84/4.09 mm) from the end of the bearing counterbore.



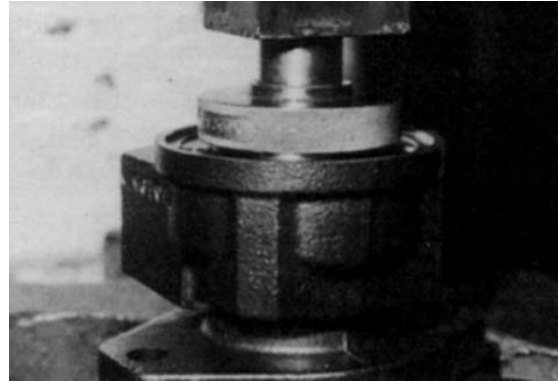

NOTE: Bearing mandrel must be pressed against the lettered end of bearing shell. Take care that the housing bore is square with the press base and the bearing/bushing is not cocked when pressing a bearing/bushing into the housing.

⚠ CAUTION

IF THE BEARING MANDREL SPECIFIED IN THE "TOOLS AND MATERIALS REQUIRED FOR SERVICING" SECTION IS NOT AVAILABLE AND ALTERNATE METHODS ARE USED TO PRESS IN BEARING/BUSHING (13) AND (19) THE BEARING/BUSHING DEPTHS SPECIFIED MUST BE ACHIEVED TO INSURE ADEQUATE BEARING SUPPORT AND CORRECT RELATIONSHIP TO ADJACENT COMPONENTS WHEN ASSEMBLED.



⚠ CAUTION

BECAUSE THE BEARING/BUSHINGS (13) AND (19) HAVE A PRESS FIT INTO THE HOUSING THEY MUST BE DISCARDED WHEN REMOVED. THEY MUST NOT BE REUSED.

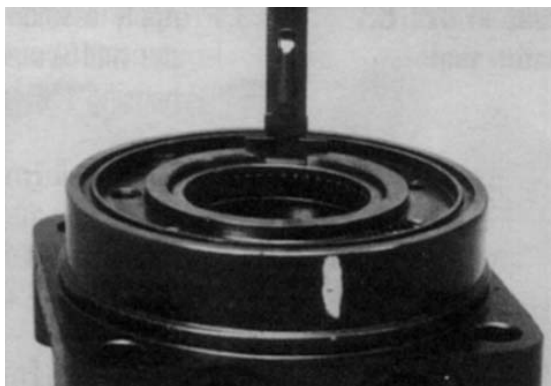

2. The Torqlink™ inner housing bearing/bushing (13) can now be pressed into its counterbore in housing (18) flush to 0.03 inch (.76 mm) below the housing wear plate contact face. Use the opposite end of the bearing mandrel that was used to press in the outer bearing/bushing (19).

3. Press a **new** dirt and water seal (20) into the housing (18) outer bearing counterbore.

The Torqlink™ dirt and water seal (20) must be pressed in until its' flange is flush against the housing.

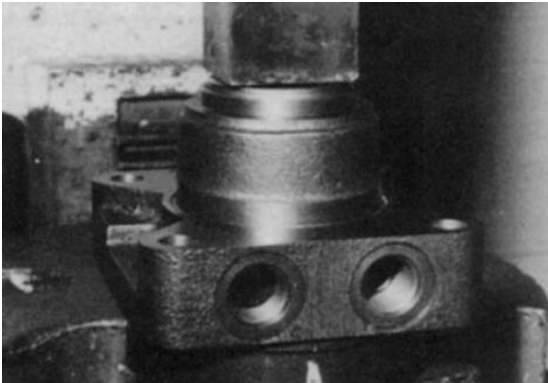
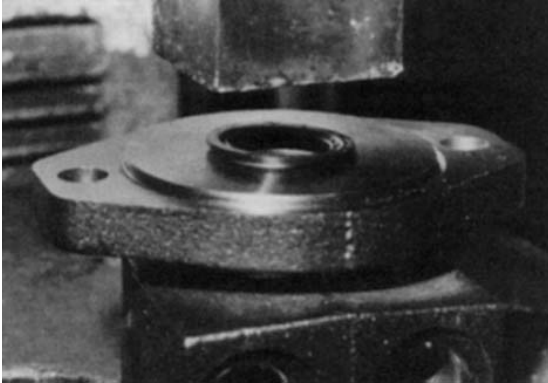

4. Place housing (18) assembly into a soft jawed vise with the coupling shaft bore down, clamping against the mounting flange.

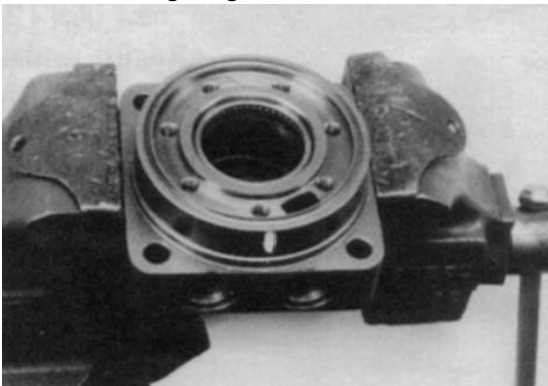

5. On the Torqlinks™ assemble a **new** backup washer (17) and **new** seal (16) with the seal lip facing toward the inside of Torqlink™, into their respective counter-bores in housing (18) if they were not assembled in procedure 2.

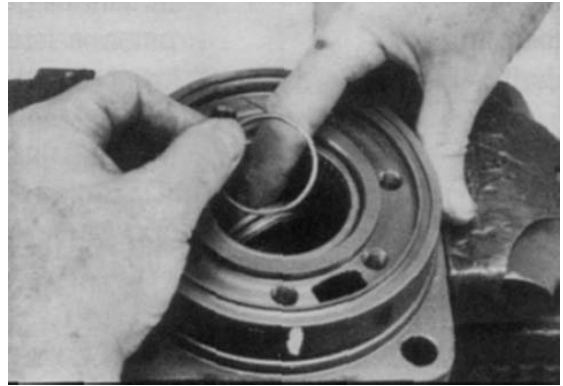

⚠ CAUTION

ORIGINAL DESIGN LARGE FRAME, TF & TG TORQLINKS™ THAT DO NOT HAVE BACKUP WASHER (25) WHEN DISASSEMBLED MUST BE ASSEMBLED WITH A NEW BACKUP WASHER (17), NEW BACKUP WASHER (25), AND NEW SEAL (16).

6. Assemble thrust washer (14) then thrust bearing (15) that was removed from the Torqlink™.



NOTE: Torqlinks™ require one thrust washer (14) with thrust bearing (15). The coupling shaft will be seated directly against the thrust

SECTION 2 - PROCEDURES

7. Apply masking tape around splines or keyway on shaft (12) to prevent damage to seal.



8. Be sure that a generous amount of clean corrosion resistant grease has been applied to the lower (outer) housing bearing/bushing (19). Install the coupling shaft (12) into housing (18), seating it against the thrust bearing (15) in the housings.

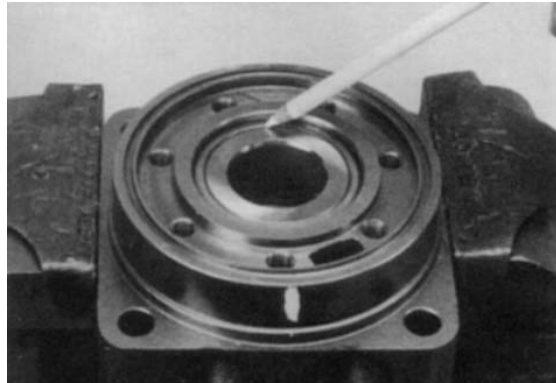
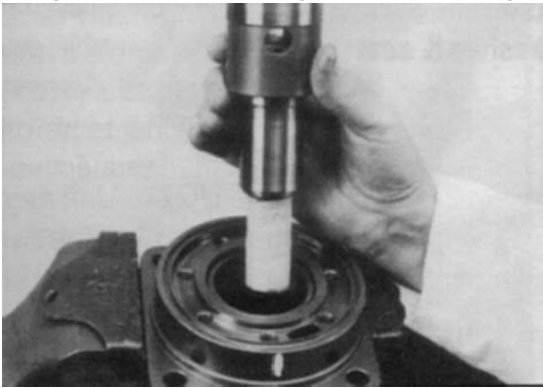

9. Apply a small amount of clean grease to a **new** seal ring (4) and insert it into the housing (18) seal ring groove.

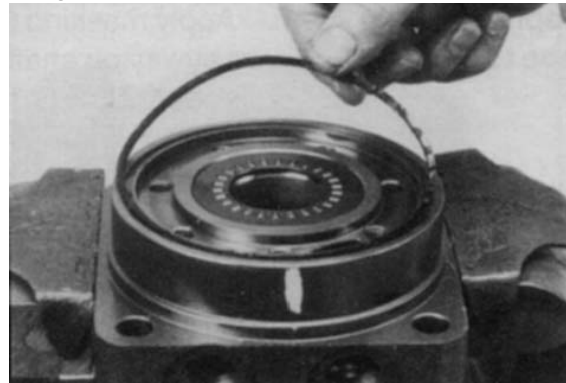

⚠ CAUTION

THE OUTER BEARING (19) IS NOT LUBRICATED BY THE SYSTEM'S HYDRAULIC FLUID. BE SURE IT IS THOROUGHLY PACKED WITH THE RECOMMENDED GREASE, PARKER GEAR GREASE SPECIFICATION #045236, E/M LUBRICANT #K-70M.

NOTE: Mobil Mobilith SHC @ 460

NOTE: A 102Tube (P/N 406010) is included in each seal kit.

NOTE: The coupling shaft (12) will be flush or just below the housing wear plate surface on Torqlinks™ when properly seated. The coupling shaft must rotate smoothly on the thrust bearing package

NOTE: One or two alignment studs screwed finger tight into housing (18) bolt holes, approximately 180 degrees apart, will facilitate the assembly and alignment of components as required in the following procedures. The studs can be made by cutting off the heads of either 3/8-24 UNF 2A or 5/16-24 UNF 2A bolts as required that are over 0.5 inch (12.7 mm) longer than the bolts (1) used in the Torqlink™.

10. Install drive link (10) the long splined end down into the coupling shaft (12) and engage the drive link splines into mesh with the coupling shaft splines.



NOTE: Use any alignment marks put on the coupling shaft and drive link before disassembly to assemble the drive link splines in their original position in the mating coupling shaft splines.

11. Assemble wear plate (9) over the drive link (10) and alignment studs onto the housing (18).

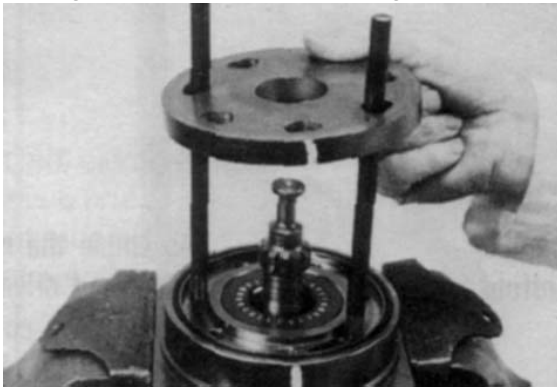

12. Apply a small amount of clean grease to a new seal ring (4) and assemble it into the seal ring groove on the wear plate side of the rotor set stator (8B).

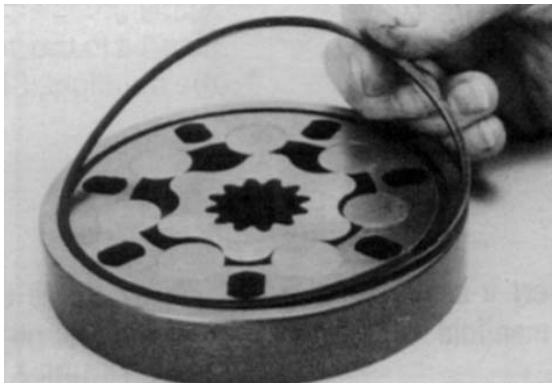

13. Install the assembled rotor set (8) onto wear plate (9) with rotor (8A) counterbore and seal ring side down and the splines into mesh with the drive link splines

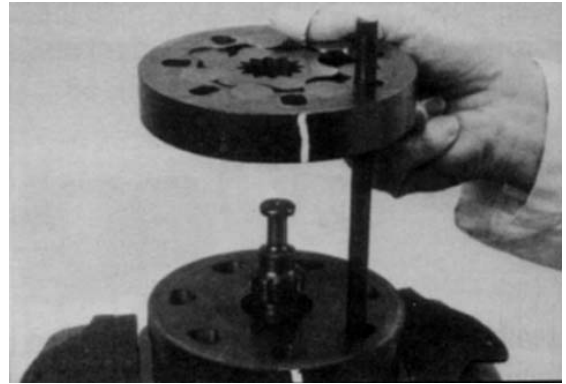

NOTE: It may be necessary to turn one alignment stud out of the housing (18) temporarily to assemble rotor set (8) or manifold (7) over the drive link.

NOTE: If necessary, go to the appropriate, "Rotor Set Component Assembly Procedure."

NOTE: The rotor set rotor counterbore side must be down against wear plate for drive link clearance and to maintain the original rotor-drive link spline contact. A rotor set without a counterbore and that was not etched before disassembly can be reinstalled using the drive link spline pattern on the rotor splines if apparent, to determine which side was down. The rotor set seal ring groove faces toward the wear plate (9).

14. Apply clean grease to a **new** seal ring (4) and assemble it in the seal ring groove in the rotor set contact side of manifold (7).

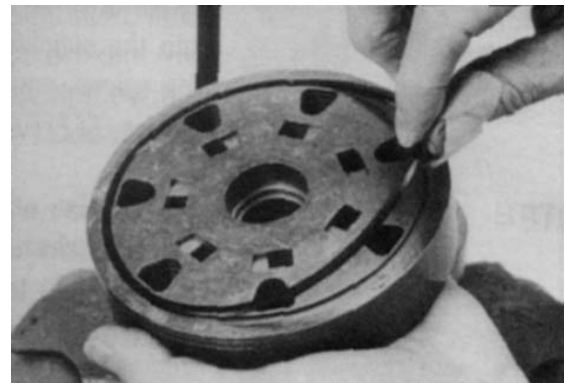

NOTE: The manifold (7) is made up of several plates bonded together permanently to form an integral component. The manifold surface that must contact the rotor set has its series of irregular shaped cavities on the largest circumference or circle around the inside diameter. The polished impression left on the manifold by the rotor set is another indication of which surface must contact the rotor set.

SECTION 2 - PROCEDURES

15. Assemble the manifold (7) over the alignment studs and drive link (10) and onto the rotor set. Be sure the correct manifold surface is against the rotor set.

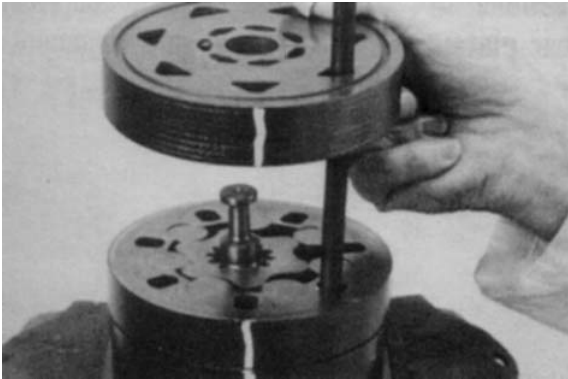

16. Apply grease to a **new** seal ring (4) and insert it in the seal ring groove exposed on the manifold.

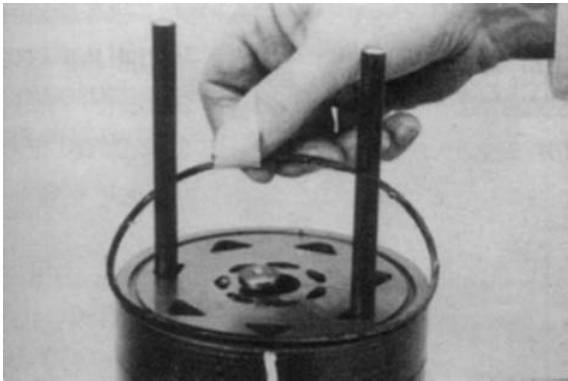

17. Assemble the commutator ring (6) over alignment studs onto the manifold.

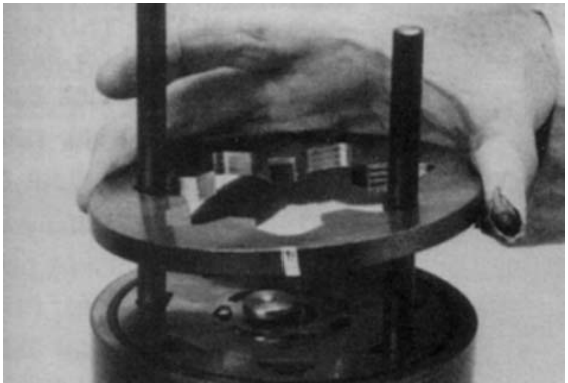

18. Assemble a **new** seal ring (3) flat side up, into commutator (5) and assemble commutator over the end of drive link (10) onto manifold (7) with seal ring side up.

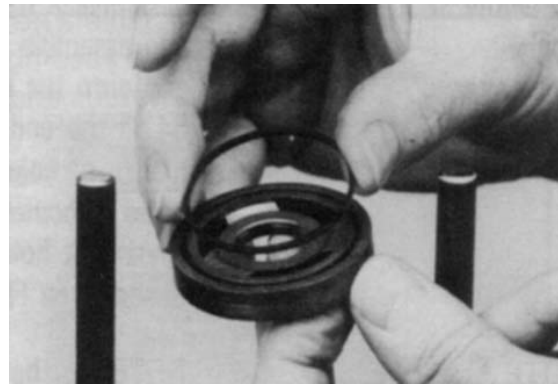

19. If shuttle valve components items #21, were removed from the end cover (2) turn a plug (21), loosely into one end of the valve cavity in the end cover. A 3/16 inch Allen wrench is required.

20. Assemble a **new** seal ring (4) into end cover (2) and assemble end cover over the alignment studs and onto the commutator set. If the end cover has only 5 bolt holes be sure the cover holes are aligned with the 5 threaded holes in housing (18). The correct 5 bolt end cover bolt hole relationship to housing port bosses.

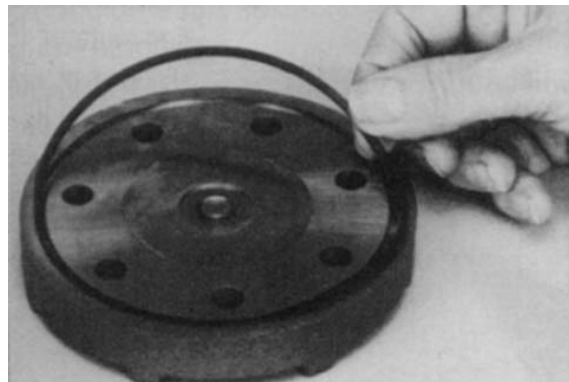

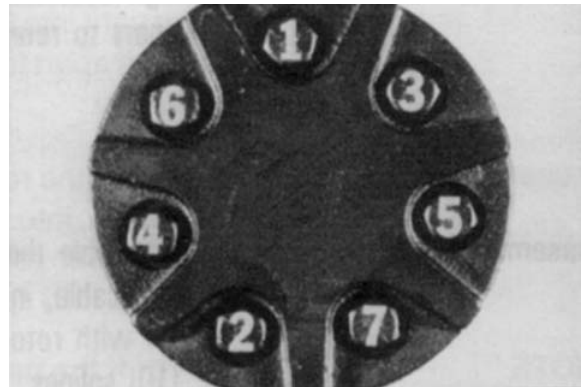
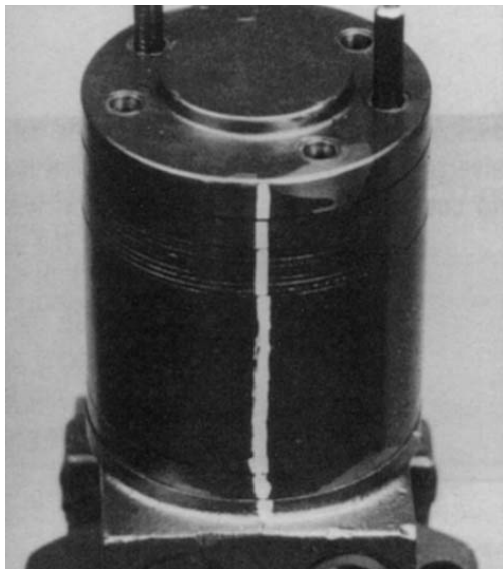
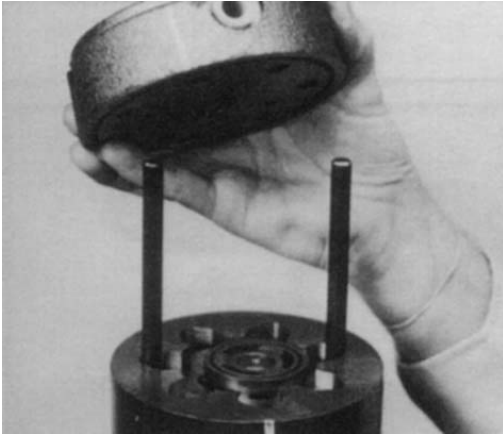

NOTE: If the end cover has a valve (24) or has five bolt holes, use the line you previously scribed on the cover to radially align the end cover into its original position.

21. Assemble the 5 or 7 special bolts (1) and screw in finger tight. Remove and replace the two alignment studs with bolts after the other bolts are in place. Alternately and progressively tighten the bolts to pull the end cover and other components into place with a final torque of 22-26 ft. lbs. 45-55 ft. lbs.(61-75 N m) for the seven 3/8-24 threaded bolts

NOTE: The special bolts required for use with the relief or shuttle valve (24) end cover assembly (2) are longer than the bolts required with standard and cover assembly. Refer to the individual service parts lists or parts list charts for correct service part number if replacement is required.

Torque the two shuttle valve plug assemblies (21) in end cover assembly to 9-12 ft. lbs. (12-16 N m) if cover is so equipped.

Torque the two relief valve plug assemblies (21) in end cover assembly to 45-55 ft.

lbs.(61-75 N m) if cover is so equipped.

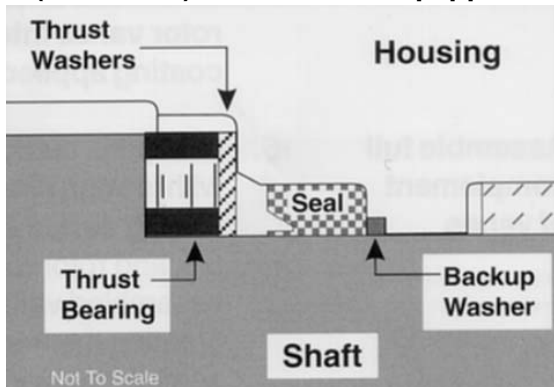

One Piece Stator Construction

A disassembled rotor (8A) stator (8B) and vanes (8C) that cannot be readily assembled by hand can be assembled by the following procedures.

1. Place stator (8B) onto wear plate (9) with seal ring (4) side down, after following Torqlink™ assembly procedures 1 through 13. Be sure the seal ring is in place.

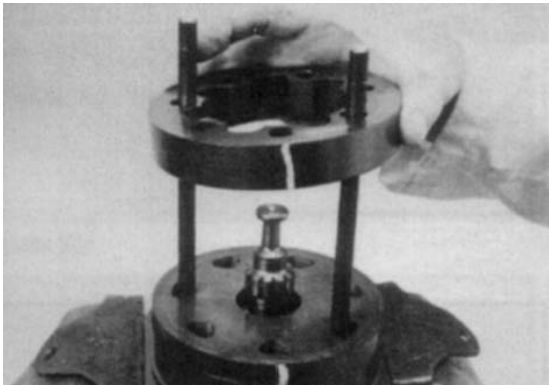

2. If assembly alignment studs are not being utilized, align stator bolt holes with wear plate and housing bolt holes and turn two bolts (1) finger tight into bolt holes approximately 180 degrees apart to retain stator and wear plate stationary.

3. Assemble the rotor (8A), counterbore down if applicable, into stator (8B), and onto wear plate (9) with rotor splines into mesh with drive link (10) splines.

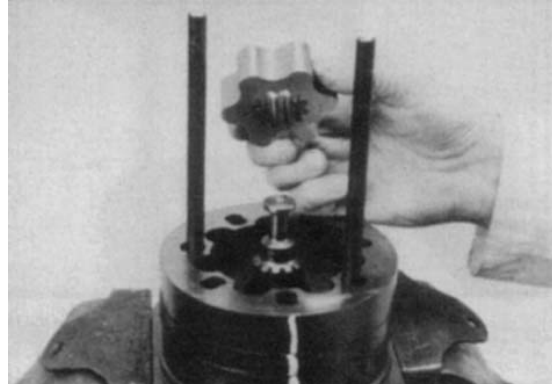

NOTE: If the manifold side of the rotor was etched during Torqlink disassembly, this side should be up. If the rotor is not etched and does not have a counterbore, use the drive link spline contact pattern apparent on the rotor splines to determine the rotor side that must be against the wear plate.

4. Assemble six vanes (8C), or as many vanes that will readily assemble into the stator vane pockets.



CAUTION

EXCESSIVE FORCE USED TO PUSH THE ROTOR VANES INTO PLACE COULD SHEAR OFF THE COATING APPLIED TO THE STATOR VANE POCKETS.

5. Grasp the output end of coupling shaft (12) with locking pliers or other appropriate turning device and rotate coupling shaft, drive link and rotor to seat the rotor and the assembled vanes (8C) into stator (8B), creating the necessary clearance to assemble

the seventh or full complement of seven vanes. Assemble the seven vanes using minimum force.

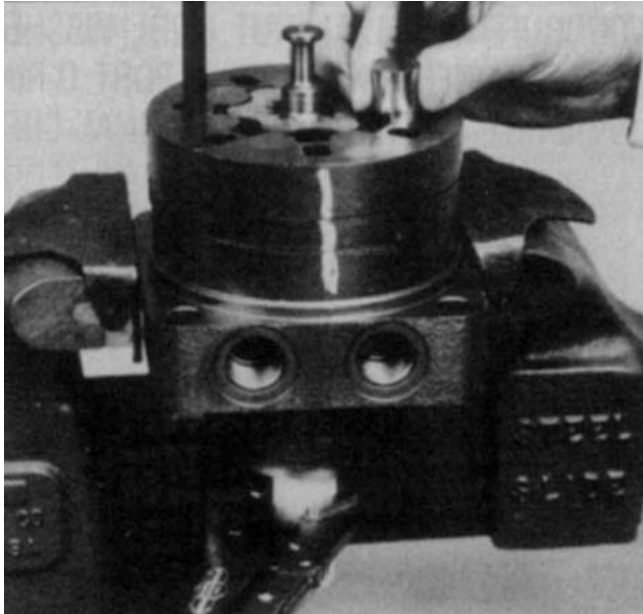

Remove the two assembled bolts (1) if used to retain stator and wear plate.

run over any uneven terrain or dropped into any void. The clearance between the top of the bolts and the frame should be a min. of 2.0 cm to a max. of 4.0 cm.

2.20 JLG SMART SYSTEM™ ANALYZER KIT INSTRUCTIONS

NOTE: The following instructions involving the JLG SMART System™ Control are used only for Model 3246E2 with the Proportional Control option.

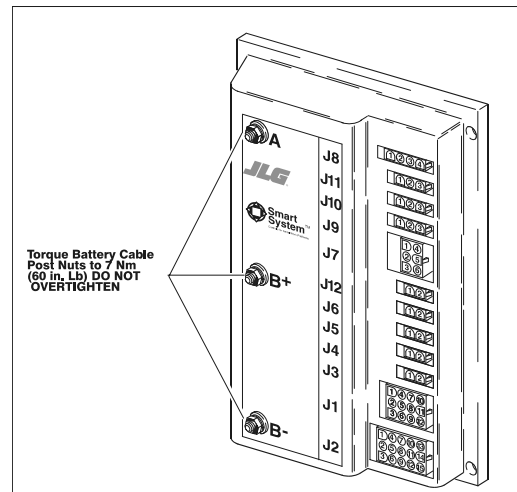

Figure 2-16. JLG SMART System™ Controller

2.18 LIMIT SWITCH ADJUSTMENT

Platform Limit Switch

The platform limit switch is located at the head of the lift cylinder on the middle inside arm. When activated, the switch cuts out the High Drive function. The cut out heights are set at a maximum of the following:

- 1932E2 - 2.6 m
- 2032E2 - 2.1 m
- 2632E2 - 2.6 m
- 2646E2 - 2.6 m
- 3246E2 - 1.6 m

2.19 DOOR ADJUSTMENT

NOTE: There is an eccentric bolt on the hinge side underneath of each door. If the door needs raised or lowered this can be accomplished by turning these bolts. Adjust these bolts to the outside to avoid drag on the pothole protection system when the door is opened.

NOTE: There are two bolts on top of each door in the corners. These are designed to take the weight off the pothole protection system and distribute it around the underside of the frame if the machine were to be

⚠ IMPORTANT

WHEN INSTALLING A NEW SMART SYSTEM CONTROLLER ON THE MACHINE, IT WILL BE NECESSARY TO PROGRAM THE CONTROLLER FOR THE PROPER MACHINE CONFIGURATION, INCLUDING OPTIONS. REFER TO ANALYZER KIT NO. 2901443.

⚠ IMPORTANT

WHEN INSTALLING A NEW SMART SYSTEM CONTROLLER ON THE MACHINE, ELECTRICAL SILICONE GREASE, JLG PART NUMBER 0100076 OR 7016397, MUST BE APPLIED TO THE BACK OF THE CONTROLLER.

⚠ IMPORTANT

IT IS A GOOD PRACTICE TO AVOID PRESSURE-WASHING ELECTRICAL/ELECTRONIC COMPONENTS. SHOULD PRESSURE-WASHING BE UTILIZED TO WASH AREAS CONTAINING ELECTRICAL/ELECTRONIC COMPONENTS, JLG INDUSTRIES, INC. RECOMMENDS A MAXIMUM PRESSURE OF 52 BAR (750 PSI) AT A MINIMUM DISTANCE OF 30.5 CM (12 IN) AWAY FROM THESE COMPONENTS. IF ELECTRICAL/ELECTRONIC COMPONENTS ARE SPRAYED, SPRAYING MUST NOT BE DIRECT AND BE FOR BRIEF TIME PERIODS TO AVOID HEAVY SATURATION.

INTRODUCTION

The JLG designed SMART System™ is a 24 Volt multiplex motor control unit installed on the electric scissor lift model 3246E2.

The SMART System™ has **reduced** the need for **exposed** terminal strips, diodes and trimpots and provides simplicity in viewing and adjusting the various personality settings for smooth control of: acceleration, deceleration, creep and max-speed for the lift, drive, steering and optional power deck functions. The function select membrane board, in the upper control box, also eliminates the need for toggle switches and a separate power enable button as this feature is built into each function select button on the board itself.

The lift, drive and optional power deck functions are controlled by a joystick, with steering being controlled by a rocker switch built into the top of the joystick. Drive, lift, and the optional power deck functions are selected by first pushing the appropriate momentary select buttons on the membrane board and then moving the joystick either in the “A” or “B” direction. If the joystick is not activated within three seconds of selecting a function, it will be necessary to re-select a function. High drive and positive traction are used in conjunction with the drive function.

The motor controller will control current output, as programmed for smooth operation and maximum cycle time. Ground control speeds for platform lift and the optional power deck are also programmed into the motor controller. The motor controller also features an adjustable time limit for positive traction. Another power saving feature is the high speed drive current limit. This feature will automatically control the drive speed and controller output when it exceeds the pre-set current limit for a specified time and reduce the motor speed, thus conserving power.

For safety, the machines are equipped with pothole protection and elevation cutback. The pothole protection is employed as the platform is raised. If the pothole protection does not extend, the drive function will be disabled. When the platform is raised, the drive function goes into creep mode.

The JLG SMART System™ controller has a built in LED to indicate any faults. The system stores recent faults which may be accessed for troubleshooting. Optional equipment includes an hourmeter, beacon light, tilt switch (light and/or alarm), power deck, power deck extension limit, function cutout, and ground alarm. These options may be added later but some must be programmed into the motor controller when installed.

The SMART System™ may be accessed by utilizing a custom designed, hand held analyzer (JLG kit no. 2901443) which will display two lines of information at a time, by scrolling through the program.

NOTE: The date code is determined by the first four digits of the controller serial number which is located on the label attached to the front of the controller.
The part number of the controller is located on the controller decal.

To Connect the Hand Held Analyzer:

1. Connect the four pin end of the cable supplied with the analyzer, to the top connection of the motor controller and connect the remaining end of the cable to the analyzer.

NOTE: The cable has a four pin connector at each end of the cable; the cable cannot be connected backwards.

2. Power up the SMART System™ by turning the lower key to the platform position and pulling both emergency stop buttons on.

Using the Analyzer:

With the machine power on and the analyzer connected properly, the analyzer will display the following:

HELP:

PRESS ENTER

At this point, using the **RIGHT** and **LEFT** arrow keys, you can move between the top level menu items. To select a displayed menu item, press **ENTER**. To cancel a selected menu item, press **ESC**; then you will be able to scroll using the right and left arrow keys to select a different menu item.

The top level menus are as follows:

HELP

DIAGNOSTICS

RUN SYSTEMS TEST (NOTE: Ensure machine is fully lowered before running systems test)

ACCESS LEVEL

PERSONALITIES

MACHINE SETUP

CALIBRATIONS (level 0 Manufactures Access Only)

If you press **ENTER**, at the **HELP:PRESS ENTER** display, and a fault is present during power up, the analyzer display will scroll the fault across the screen. If there was no fault detected during power up, the display will read:
HELP: EVERYTHING OK

If **ENTER** is pressed again, the display moves to the following display:

LOGGED HELP

1: STARTUP (2/1)

At this point, the analyzer will display the current fault, if any are present. You may scroll through the fault logs to view what the last fifteen faults were. Use the right and left arrow keys to scroll through the fault logs. To return to the beginning, press **ESC** two times.

NOTE: The *STARTUP (2/1)* is not a fault. It is used to separate faults between powerups.

When a top level menu is selected, a new set of menu items may be offered; for example:

PLATFORM
GROUND
SYSTEMS
DATA LOG
VERSIONS
DRIVE
LIFT
STEER
GROUND MODE
MACHINE

Pressing **ENTER** with any of the above displayed menus, will display additional sub-menus within the selected menu. In some cases, such as **DRIVE**, the next level is the parameter or information to be changed. Refer to the flow chart for what menus are available within the top level menus. You may only view the personality settings for selected menus while in access level 2. Remember, you may always cancel a selected menu item by pressing the **ESC** key.

Changing the Access Level of the Hand Held Analyzer:

When the analyzer is first connected, you will be in access level 2 which enables you to only view most configuration settings which cannot be changed until you enter a password to advance to a lower level. This ensures that a setting cannot be accidentally altered. To change the access level, the correct password must be entered. To enter the password, scroll to the **ACCESS LEVEL** menu. For example:

MENU:
ACCESS LEVEL 2

Press **ENTER** to select the **ACCESS LEVEL** menu.

Using the **UP** or **DOWN** arrow keys, enter the first digit of the password, 3.

Then using the **RIGHT** arrow key, position the cursor to the right one space to enter the second digit of the password.

Use the **UP** or **DOWN** arrow key to enter the second digit of the password which is 3.

Repeat this process until you have entered all five digits of the password which is **33271**.

Once the correct password is displayed, press **ENTER**.

The access level should display the following, if the password was entered correctly:

MENU:
ACCESS LEVEL 1

Repeat the above steps if the correct access level is not displayed or you can not adjust the personality settings.

Adjusting Configuration Using the Hand Held Analyzer on All 1600286 Controllers:

Once you have gained access to level 1, and a personality item is selected, press the **UP** or **DOWN** arrow keys to adjust its value, for example:

PERSONALITIES:
DRIVE ACCEL 1.0s

There will be a minimum and maximum for the value to ensure efficient operation. The value will not increase if the **UP** arrow is pressed when at the maximum value nor will the value decrease if the **DOWN** arrow is pressed and the value is at the minimum value for any particular personality. If the value does not change when pressing the up and down arrows, check the access level to ensure you are at access level 1.

When a machine digit item is selected, press the **UP** or **DOWN** arrow keys to adjust its value, for example:

GROUND ALARM:
2=DRIVE

The effect of the machine digit value is displayed along with its value. The above display would be selected if the machine was equipped with a ground alarm and you wanted it to sound when driving. There are certain settings allowed to install optional features or select the machine model.

When selecting the machine model to match the size of the machine, the personality settings will all default to the factory recommended settings.

SECTION 2 - PROCEDURES

NOTE: Refer to the appropriate Machine Personality Settings Table, and the Machine Setup Table in the JLG Service Manual for the recommended factory settings. Refer to the JLG part number of the controller, printed on the front label, to select the correct table in the manual.

NOTE: Password 33271 will give you access to level 1, which will permit you to change all machine personality settings. There are some settings that JLG strongly recommends that you do not change. These settings are so noted below:

ELEVATION CUTBACK

POSITRAC TIMEOUT

HIGH DRIVE CURRENT LIMIT

HIGH DRIVE TIME LIMIT

⚠ WARNING

CHANGING THESE SETTINGS MAY ADVERSELY AFFECT THE PERFORMANCE OF YOUR MACHINE.

⚠ IMPORTANT

WHEN INSTALLING A NEW SMART SYSTEM CONTROLLER ON THE MACHINE, ELECTRICAL SILICONE GREASE, JLG PART NUMBER 0100076 OR 7016397, MUST BE APPLIED TO THE BACK OF THE CONTROLLER.

⚠ IMPORTANT

IT IS A GOOD PRACTICE TO AVOID PRESSURE-WASHING ELECTRICAL/ELECTRONIC COMPONENTS. SHOULD PRESSURE-WASHING BE UTILIZED TO WASH AREAS CONTAINING ELECTRICAL/ELECTRONIC COMPONENTS, JLG INDUSTRIES, INC. RECOMMENDS A MAXIMUM PRESSURE OF 52 BAR (750 PSI) AT A MINIMUM DISTANCE OF 30.5 CM (12 IN) AWAY FROM THESE COMPONENTS. IF ELECTRICAL/ELECTRONIC COMPONENTS ARE SPRAYED, SPRAYING MUST NOT BE DIRECT AND BE FOR BRIEF TIME PERIODS TO AVOID HEAVY SATURATION.

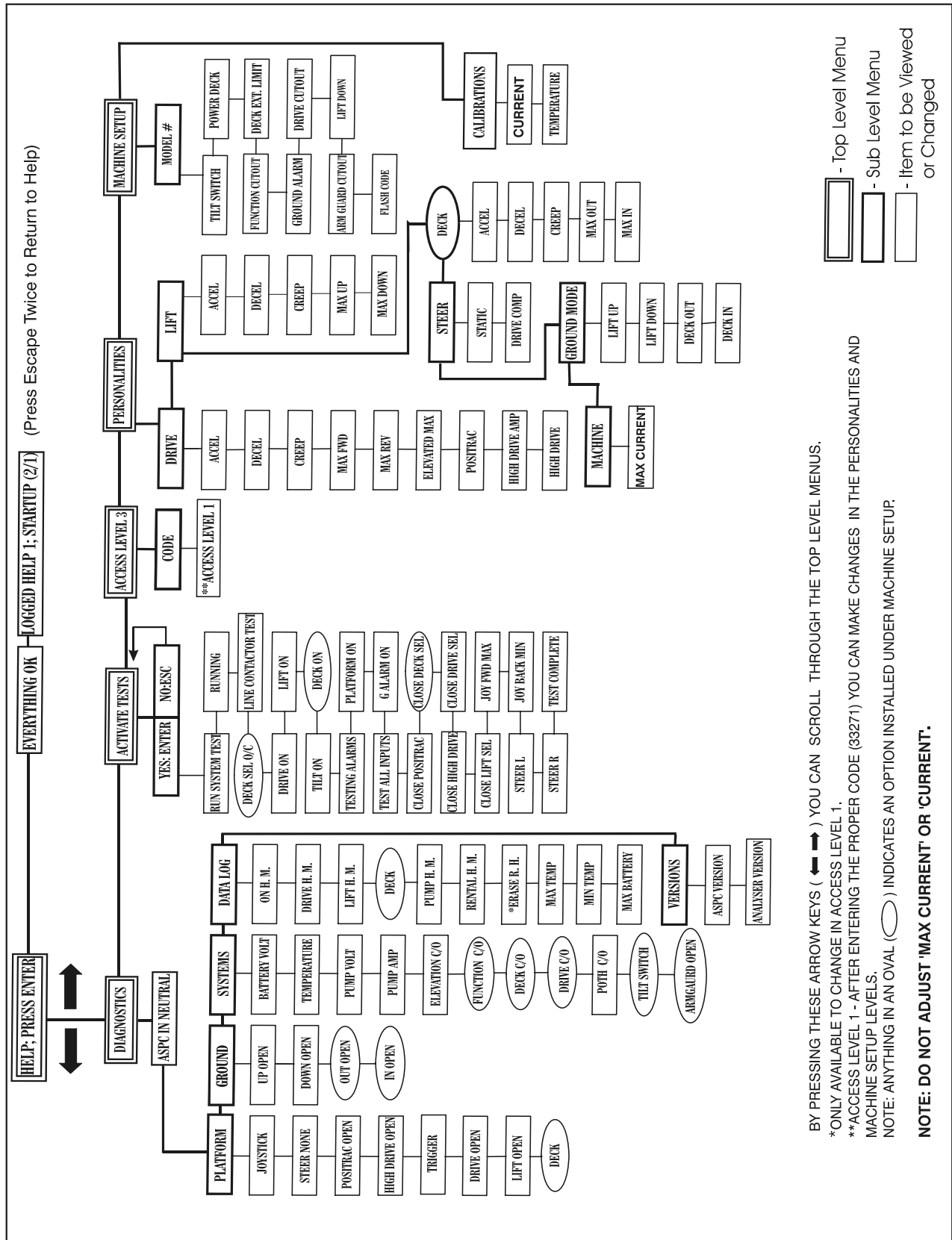

Figure 2-17. Organizational Chart

2.21 MACHINE PERSONALITY SETTINGS

Table 2-4. Machine Personality Settings

PERSONALITY	MIN	MAX
DRIVE-ACCEL	0.5 SEC	5.0 SEC
DRIVE-DECEL	0 SEC	5.0 SEC
DRIVE CREEP	1%	25.0%
DRIVE SPEED MAX (LOW)	50%	100%
DRIVE SPEED MAX (HIGH)	50%	100%
*ELEVATION MAX	*0%	*40%
*POSI-TRAC TIME	*0 Sec	*60 Sec
*HIGH DRIVE OVERCURRENT	*50 Amp	*200 Amp
HIGH DRIVE TIME OUT	0 Sec	25 Sec
LIFT ACCEL	0.5 Sec	5.0 Sec
LIFT DECEL	0.0 Sec	1.5 Sec
LIFT CREEP	1%	25%
LIFT UP MAX	50%	100%
MAX DOWN	30%	100%
DECK ACCEL	0.5 Sec	5.0 Sec
DECK DECEL	0 Sec	5 Sec
DECK CREEP	1%	25%
DECK EXT MAX	0	100%
DECK RET MAX	0	100%
STEER STATIC	20%	50%
STEER (DRIVE COMP)	0	35%
GROUND LIFT UP MAX	0%	100%
GROUND LIFT DOWN	0%	100%
GROUND DECK OUT	0%	100%
GROUND DECK IN	0%	100%
<p>*JLG strongly recommends that these settings not be changed. Changing these settings may adversely affect the performance of your machine.</p> <p>NOTE: Personality settings can be adjusted within the adjustment range in order to achieve optimum machine performance.</p>		

2.22 MACHINE MODEL DEFAULT SETTINGS

Table 2-5. Machine Model Default Settings Chart

Adjustment	3246E2
DRIVE ACCELERATION	1.0 sec
DRIVE DECELERATION	0.5 sec
DRIVE CREEP	12%
DRIVE SPEED MAX (LOW)	100%
DRIVE SPEED MAX (HIGH)	85%
ELEVATION MAX*	42%*
POSITRAC TIME	10 sec
HIGH DRIVE OVERCURRENT	140 amps
HIGH DRIVE TIME OUT*	5.0 sec**
LIFT ACCEL	1.0 sec
LIFT DECEL	0.0 sec
LIFT CREEP	15%
LIFT UP MAX	100%
DECK ACCEL	0.5 sec
DECK DECEL	0.0 sec
DECK CREEP	10%
DECK EXTENSION SPEED MAX.	10%
DECK RETRACTION MAX	80%
STATIC STEER	30%
STEER (DRIVE COMP)	15%
GROUND LIFT UP MAX	100%
GROUND DECK IN MAX	50%
GROUND DECK OUT MAX	40%

NOTE: WARNING: Changing the machine model will set all personalities back to the factory default settings. check the machine model adjustment chart for the correct settings for each model. if your machine does not match the proper settings for each model, adjust the settings as necessary in accordance with the chart.

NOTE: * JLG strongly recommends that these settings not be changed. Changing these settings may adversely affect the performance of your machine.

2.23 MACHINE CONFIGURATION INFORMATION

NOTE: The following information is to be used when working with the MACHINE SETUP menu. When configuring the E Series scissor lift, the machine configuration

must be completed before any personality settings can be changed. Changing the personality settings first and then changing the model number of the machine configuration will cause the personality settings to return to default values.

Table 2-6. Machine Configuration Programming Information

Configuration Digit	Number	Description	Default Setting Before Programming
1 (MODEL NUMBER)	1	MODEL 1532E3	3
	2	MODEL 1932E3	
	3	MODEL 2033E3	
	4	MODEL 2046E3	
	5	MODEL 2646E3	
	6	MODEL 2658E3	
	7	MODEL 3246E2	
2 (TILT SWITCH)	0	No tilt switch installed.	0
	1	Tilt switch installed for North American, CE, and optional for Latin American machines. This digit will allow the SMART System™ to indicate when the machine is out of level by lighting the light in the platform box. If the machine is elevated and tilted, the SMART System™ will also sound the platform alarm continuously. No functions are cutback or cutout.	
	2	Tilt switch for Australia, Japanese, and option for Latin American machines. This digit will allow the SMART System™ to indicate when the machine is out of level by lighting the light in the platform box. If the machine is elevated and tilted, the SMART System™ will also sound the platform alarm continuously and the lift up and drive functions are cutout.	
3 (POWER DECK)	0	No power deck installed.	0
	1	Machine equipped with power deck.	
4 (DECK EXT. LIMIT SWITCH)	0	Deck extension limit switch not installed. (This cannot be zero if there is a power deck installed.)	0
	1	Cuts out LIFT DOWN when deck is extended. This digit is used with roll out decks that require a deck extension cutout. Sounds platform alarm for one second on, one second off, one second on, and three seconds off while operator tries to perform the function that has been cut out (provided the platform alarm has been installed).	
	2	Cuts out HIGH DRIVE when deck is extended and below elevation. Cuts out DRIVE when deck is extended and above elevation. This digit is used with a power deck. Sounds platform alarm for one second on, one second off, one second on, and three seconds off while operator tries to perform the function that has been cut out and during the LIFT DOWN function (provided the platform alarm has been installed).	

Table 2-6. Machine Configuration Programming Information

Configuration Digit	Number	Description	Default Setting Before Programming
5 (FUNCTION CUTOUT)	0	No function cutout installed.	0
	1	Overload switch for French, Japanese machines. — Cuts out all functions. Sounds platform alarm for two seconds on, two seconds off, while operator tries to perform the function that has been cut out (provided the platform alarm is installed).	
6 (GROUND ALARM)	0	No ground alarm installed.	0
	1	Descent alarm. — Sounds when LIFT DOWN is active.	
	2	Travel alarm. — Sounds when DRIVE function is active.	
	3	Motion alarm. — Sounds whenever the DRIVE, LIFT or DECK function is active.	
7 (DRIVE CUTOUT)	0	No drive cutout switch installed.	0
	1	Cuts out DRIVE when deck is elevated above a predetermined elevation (varies with machine model).	
8 (ARM GUARDS))	0	No arm guard cutout.	0
	1	European (CE Specification) machines— LIFT DOWN cutout must activate when the gap between the arms is 5 in. to 8 in. (13 cm to 20 cm). Here it will cut out LIFT DOWN and sound the platform alarm for 1/2 second on, 1/2 second off, and repeat this for three seconds. After three seconds, the operator must re-select the LIFT function and continue to operate LIFT DOWN. If the wires to the limit switch used to detect the deck height are cut or the switch has failed, the platform alarm will sound as mentioned. The operator can re-select the LIFT function and then LIFT DOWN for ten seconds, at which time it will cut out again and the process must be repeated.	
9 (Flash Codes)	0	LED Only	0
	1	LED and lamps in platform control box	
	2	LED and alarm	
	3	LED, lamps in control box and alarm	

**2.24 JLG SMART SYSTEM™ HELP
MESSAGES AND FLASH CODES**

Table 2-7. Help Messages

NO FLASH CODE IS INDICATED FOR THE FOLLOWING HELP MESSAGES; THEY ARE INTENDED TO HINT AT A POSSIBLE PROBLEM IF THE MACHINE IS NOT BEHAVING AS EXPECTED	
EVERYTHING OK	The "normal" help message in platform mode.
GROUND MODE OK	The "normal" help message in ground mode.
ALARM SOUNDING: ARMGAURD PROTECTION ACTIVE	Arm guard protection has tripped during lift down and is preventing lift down for three seconds.
ALARM SOUNDING: DECK EXTENDED DURING LIFT DOWN	The deck extension cutout is preventing lift down.
ALARM SOUNDING: OVERLOADED	The function cutout is active; some functions may be prevented.
ALARM SOUNDING: TILTED & ABOVE ELEVATION	The machine is tilted while above elevation; some functions may be prevented.
DECK PREVENTED - NOT AVAILABLE	A deck function has been selected but there is no power deck.
DIFFERENT FUNCTION SELECTED & IGNORED	A platform function selection (drive, lift, or deck) has been pressed while another function is in use.
DRIVING AT CUTBACK - ABOVE ELEVATION	Drive speed is limited to cutback because the machine is above elevation.
DRIVING AT CUTBACK - POTHOLE STILL ENGAGED	drive speed is limited to cutback because the pothole protection is still engaged while the machine is not above elevation.
FUNCTION SELECTED BUT TRIGGER SWITCH OPEN	A function has been selected but the trigger switch is open; when the trigger switch is closed the function will begin if it is still selected.
HIGH DRIVE PROBLEM - CUTOUT	The high drive function has been selected but is prevented by a cutout (high drive is not allowed while above elevation or when the deck is extended).
HIGH DRIVE PROBLEM - MOTOR CURRENT EXCEEDED	The high drive function was selected but was ended because pump motor current was to high
JOYSTICK MOVED BUT NO FUNCTION SELECTED	The drive, lift or deck function must be selected before the joystick is moved from neutral.
POSITRAC PROBLEM - NOT ALLOWED DURING HIGH DRIVE	The positrac function has ben selected but is not allowed while the high drive function is in use.
PUMP MOTOR AT CURRENT LIMIT	Pump motor current has reached the maximum allowed and is being limited.
STEER SELECTED BUT TRIGGER SWITCH OPEN	Steering has been selected but the trigger switch is open; when the trigger switch is closed steering will begin if it is still selected.
TESTS ACTIVE - RECYCLE EMS TO END	The system tests have been activated; normal machine operation is not allowed.

Table 2-8. JLG SMART System™ Flash Codes & Help Messages

Code	Description
2-1 - Indicates problems with EMS inputs	<p>STARTUP - Neither EMS is active - the system is just switching on or is discharging the capacitor bank. A welded line contactor might also cause this.</p>
2-2 - Indicates problems with platform controls	<p>ALL FUNCTIONS PREVENTED - NO DATA FROM PLATFORM BOX - The signal from the MUX board in the platform box is not available; drive, lift and deck functions cannot be selected.</p> <p>FUNCTION PROBLEM - PERMANENTLY SELECTED - The drive, lift or deck function select is active for more than ten seconds; any active function will be stopped.</p> <p>FUNCTIONS LOCKED OUT - RELEASE THEN RESELECT - The selected function is not allowed; release the joystick to clear the fault.</p> <p>HIGH DRIVE PROBLEM - PERMANENTLY SELECTED - The high drive function select is active for more than ten seconds; the high drive function will be stopped.</p> <p>FUNCTION SELECTED BUT TRIGGER NEVER CLOSED - Occurs after ten seconds with the joystick in neutral, but trigger switch never closed.</p> <p>JOYSTICK FAULTY - WIPER OUT OF RANGE - Occurs if wiper voltage is invalid.</p> <p>JOYSTICK FAULTY - CENTER OUT OF RANGE - Occurs if center tap voltage is invalid.</p> <p>JOYSTICK FAULTY - STEER SWITCHES ACTIVE TOGETHER</p> <p>JOYSTICK LOCKED OUT - RELEASE THEN RESELECT</p> <p>PORITRAC PROBLEM - PERMANENTLY SELECTED</p> <p>TRIGGER INTERLOCK TRIPPED - Trigger switch was closed for more than ten seconds with no function selected.</p> <p>WAITING FOR TRIGGER SWITCH TO BE OPEN - Trigger switch was closed when platform mode was selected.</p>
2-3 - Indicates problems with ground controls	<p>GROUND FUNCTIONS LOCKED OUT - RELEASE THEN RESELECT - A ground mode function (lift or deck) was selected when ground mode was selected</p>
2-5 - Indicates a function is prevented due to a cutout	<p>DECK PREVENTED - FUNCTION CUTOFF ACTIVE</p> <p>DRIVE PREVENTED - DECK EXTENDED & ABOVE ELEVATION</p> <p>DRIVE PREVENTED - DRIVE CUTOFF ACTIVE - Drive is selected while drive cutout is active and drive cutout is configured to prevent drive.</p> <p>DRIVE PREVENTED - FUNCTION CUTOFF ACTIVE - Drive is selected while function cutout ("overload") is active and configured to cut out drive functions.</p> <p>DRIVE PREVENTED - POTHOLE NOT ENGAGED</p> <p>DRIVE PREVENTED - TILTED & ABOVE ELEVATION - Drive is selected while tilted and above elevation and tilt is configured to prevent drive.</p> <p>LIFT DOWN CUTOFF - ARMGUARD PROTECTION ACTIVE</p> <p>LIFT DOWN PREVENTED - DECK EXTENDED</p> <p>LIFT PREVENTED - FUNCTION CUTOFF ACTIVE</p> <p>LIFT UP PREVENTED - TILTED & ABOVE ELEVATION</p> <p>STEER LOCKED OUT - RELEASE THEN RESELECT</p> <p>STEER PREVENTED - DECK EXTENDED & ABOVE ELEVATION</p> <p>STEER PREVENTED - FUNCTION CUTOFF ACTIVE</p> <p>STEER PREVENTED - NOT AVAILABLE</p> <p>STEER PREVENTED - TILTED & ABOVE ELEVATION</p>
3-1 - Indicates that a contactor did not close when energized	<p>OPEN-CIRCUIT LINE CONTACTOR - The capacitor bank charge did not increase to battery supply when line contactor was energized (this could be due to a power wiring error).</p>
3-2 - Indicates that a contactor did not open when de-energized	<p>WELDED LINE CONTACTOR - The capacitor bank charge did not decrease from battery supply when line contactor was de-energized (this could be due to a power wiring error).</p>

SECTION 2 - PROCEDURES

Table 2-8. JLG SMART System™ Flash Codes & Help Messages

Code	Description
3-3 - Indicates that a contactor coil is short-circuit	<p>SHORT-CIRCUIT LINE CONTACTOR COIL - The line contactor was not energized when required, due to coil over current protection.</p> <p>VALVE OR LINE CONTACTOR ENERGIZED - CHECK WIRING - The drive circuit to the line contactor or a valve is active when no driver circuit is turned on (this could be due to a wiring error to the valves or line contactor).</p>
4-2 - indicates that the controller is over temperature	<p>CONTROLLER TOO HOT - PLEASE WAIT - The controller heat sink temperature reached 75 degrees. The controller is shut down until it cools to below 70 degrees.</p>
4-4 - Indicates problems with the battery supply	<p>BATTERY TOO LOW - SYSTEM SHUT DOWN - Battery voltage is below 17V. EMS recycle required.</p> <p>BATTERY TOO HIGH - SYSTEM SHUT DOWN - Battery voltage is above 30 V. EMS recycle required.</p>
7-7 - Indicates problems with a motor	<p>CAPACITOR BANK FAULT - CHECK MOTOR WIRING - The capacitor bank is not charging. This is probably due to a power wiring error causing illegal current drain; it could also be due to a very low battery supply.</p> <p>POINT A LOW - CHECK POWER CIRCUITS - Pump point A is low when the MOSFETs are off. This is probably due to power wiring error.</p> <p>PUMP MOTOR OPEN-CIRCUIT - CHECK MOTOR & WIRING - Pump point A is collapsing when the pump MOSFETs are pulsed. This is probably due to an open circuit pump motor or a power wiring error.</p> <p>PUMP MOTOR STALLED - CHECK MOTOR & WIRING - The pump MOSFET protection circuit is active. This is due to massive current drain and could be a stalled pump motor or power wiring error.</p>
9-9 - Indicates problems with the controller	<p>CONTROLLER FAILURE: HWFS TEST STALLED - The hardware fail safe tests did not complete, but no reason can be determined.</p> <p>CONTROLLER FAILURE: HWFS TEST STALLED 15 - The hardware fail safe tests failed because the contactor drive fail safe did not trip within the allowed test time.</p> <p>NOTE: Anytime a reading of a 15- code appears the controller must be replaced</p>

2.25 ANALYZER MENU STRUCTURE

In the following structure descriptions, an intended item is selected by pressing ENTER; pressing ESC steps back to the next outer level. The LEFT/RIGHT arrow keys move

between items in the same level. The UP/DOWN arrow keys alter a value if allowed

Table 2-9. Analyzer Menu Structure

TOP LEVEL MENU	SUB LEVEL MENU	ITEM TO BE VIEWED OR CHANGED	DESCRIPTION DISPLAY
HELP;PRESS ENTER	HELP LOGGED HELP		Displays current help/fault message Log of most recent help/fault messages: LEFT/RIGHT view
DIAGNOSTICS	ASPC IN... PLATFORM	JOYSTICK STEER POSI-TRAC HIGH DRIVE TRIGGER DRIVE LIFT DECK	Displays current controller mode. NEUTRAL/DRIVE/FORWARD/LIFT/etc. Displays joystick demand 0%...100% Preceded by "+" for forward/up/out, or by "-" for reverse/down/in. Displays steer status. (NONE/LEFT/RIGHT/etc.) Displays posi-trac switch status (OPEN/CLOSED) Displays high drive switch status (OPEN/CLOSED) Displays trigger switch status (OPEN/CLOSED) Displays drive mode select switch status (OPEN/CLOSED) Displays lift mode select switch status (OPEN/CLOSED) Displays deck mode select switch status (OPEN/CLOSED) Not displayed if POWER DECK = NO
	GROUND	UP DOWN OUT IN	Displays ground lift up switch status (OPEN/CLOSED) Displays ground lift down switch status (OPEN/CLOSED) Displays ground deck out switch status (OPEN/CLOSED) Not displayed if POWER DECK = NO Displays ground deck in switch status (OPEN/CLOSED) Not displayed if POWER DECK = NO

SECTION 2 - PROCEDURES

Table 2-9. Analyzer Menu Structure

TOP LEVEL MENU	SUB LEVEL MENU	ITEM TO BE VIEWED OR CHANGED	DESCRIPTION DISPLAY
	SYSTEMS	BATTERY TEMPERATURE PUMP VOLT PUMP AMP ELEVATION	Displays measured battery voltage NOTE: Only accurate when line contactor closed Displays measured heatsink temperature Displays calculated pump motor voltage Displays calculated pump motor current Displays elevation cutout switch status (OPEN/CLOSED) Closed with platform fully lowered
DIAGNOSTICS/SYSTEMS (Continued)		FUNCTION C/O DECK C/O DRIVE C/O POTH C/O TILT ARMGUARD	Displays function cutout switch status (OPEN/CLOSED) Not displayed if FUNTION CUTOUT=NO Displays function cutout switch status (OPEN/CLOSED) Not displayed if POWER DECK=NO Displays function cutout switch status (OPEN/CLOSED) Not Displayed if DRIVE CUTOOUT = NO Displays pothole cutout switch status (OPEN/CLOSED) Displays tilt switch status (LEVEL /TILTED) Not Displayed if TILT SWITCH = NO Displays armguard cutout switch status (OPEN/CLOSED) Not displayed if ARMGUARD CUTOOUT = NO

Table 2-9. Analyzer Menu Structure

TOP LEVEL MENU	SUB LEVEL MENU	ITEM TO BE VIEWED OR CHANGED	DESCRIPTION DISPLAY
	DATALOG	ON	Displays total controller on time NOTE: Up to four minutes lost at switch-off
		DRIVE	Displays total controller drive operation time
		LIFT	Displays total controller lift operation time
		DECK	Displays total controller deck operation time NOTE: Not displayed if POWER DECK = NO
		PUMP	Displays total controller pump running time NOTE: Includes drive, lift up, deck and steer
		RENTAL	Displays total controller pump running time NOTE: Can be reset
		ERASE RENTAL (YES:ENTER,NO ESC)	Not available in level 3 ENTER resets rental datalog time to zero
		MAX. TEMP	Displays maximum measured heatsink temperature
		MIN. TEMP	Displays minimum measured heatsink temperature
		MAX BATTERY	Displays maximum measured battery voltage
	VERSIONS	ASPC	Displays controller software version
		ANALYZER	Displays analyzer software version
ACTIVATE TESTS	YES:ENTER,NO:ESC		Not available once tests are activated
	RUN SYSTEM TEST (Machine must be fully lowered before running systems test)		ENTER activates system test NOTE: Cannot be done while controller is use (trigger switch closed)
			ENTER starts system test
			Not available until tests are activated
			Displays messages while system test runs
			Some messages are prompts, requiring user intervention
			ENTER can be pressed if a fault has been noted and to continue the system test. NOTE: A flashing message is critical, and prevents the system test from running.

SECTION 2 - PROCEDURES

Table 2-9. Analyzer Menu Structure

TOP LEVEL MENU	SUB LEVEL MENU	ITEM TO BE VIEWED OR CHANGED	DESCRIPTION DISPLAY
ACCESS LEVEL	CODE		<p>Displays the current access level Level 3 - Personalities cannot be changed Level 2 - Most personalities can be changed Level 1 - All personalities can be changed</p> <p>Allows access level password to be entered Use LEFT/RIGHT to select digit Use UP/DOWN to change digit Use ENTER to update access level</p>
PERSONALITIES	DRIVE	ACCEL DECEL CREEP LOW MAX HIGH MAX ELEVATED MAX POSI-TRAC HIGH DRIVE AMP HIGH DRIVE	<p>Displays/adjusts drive acceleration</p> <p>Displays/adjusts drive deceleration</p> <p>Displays/adjusts minimum drive speed</p> <p>Displays/adjusts maximum "low" drive speed NOTE: Used when high drive not selected</p> <p>Displays/adjusts maximum "high" drive speed NOTE: Used when high drive not selected</p> <p>Displays/adjusts maximum drive speed elevated NOTE: Used when elevation or pothole cutout switches are limiting max speed NOTE: Only adjustable in access level 1</p> <p>Displays/adjusts posi-trac engaged time-out</p> <p>Displays /adjusts high drive motor overload current NOTE: Only adjustable in access level 1</p> <p>Displays/adjusts high drive motor overload time-out</p>
	LIFT	ACCEL DECEL CREEP MAX UP MAX DOWN N/A	<p>Displays/adjusts lift acceleration</p> <p>Displays/adjusts lift deceleration</p> <p>Displays/adjusts minimum lift (up) speed</p> <p>Displays/adjusts maximum lift (up) speed</p> <p>Displays if there is no lift down (gravity) Displays/adjusts for power down machines for maximum lift down speed</p>

Table 2-9. Analyzer Menu Structure

TOP LEVEL MENU	SUB LEVEL MENU	ITEM TO BE VIEWED OR CHANGED	DESCRIPTION DISPLAY
	DECK	ACCEL	Displays/adjusts deck acceleration
		DECEL	Displays/adjusts deck deceleration
		CREEP	Displays/adjusts minimum deck speed
		MAX OUT	Displays/adjusts maximum deck out speed
		MAX IN	Displays/adjusts maximum deck in speed
	STEER	STATIC	Displays/adjust steer speed NOTE: Used when not driving
		DRIVE COMP	Displays/adjusts steer compensation speed NOTE: Used as an additive when driving NOTE: Only adjustable in access level 1
	GROUND MODE	LIFT UP	Displays/adjusts fixed lift up speed
		LIFT DOWN N/A	Displays if no power lift down NOTE: Adjustable for power down machines
		DECK OUT	Displays/adjusts fixed deck speed out NOTE: Not displayed if POWER DECK = NO
		DECK IN	Displays/adjusts fixed deck speed in NOTE: Not displayed if POWER DECK = NO
	MACHINE	CURRENT	Displays/adjusts maximum motor current NOTE: DO NOT ADJUST

SECTION 2 - PROCEDURES

Table 2-9. Analyzer Menu Structure

TOP LEVEL MENU	SUB LEVEL MENU	ITEM TO BE VIEWED OR CHANGED	DESCRIPTION DISPLAY
MACHINE SETUP		MODEL NUMBER	Displays/adjusts machine model NOTE: All personalities reset to default when model number is altered
		TILT SWITCH	Displays/adjusts tilt switch presence/function
		POWER DECK	Displays/adjusts power deck presence
		DECK EXT. LIMIT	Displays/adjusts deck extension cutout switch presence/function
		FUNCTION CUTOFF	Displays/adjusts function cutout switch presence/function
		GROUND ALARM	Displays/adjusts ground alarm presence/function
		DRIVE CUTOFF	Displays/adjusts drive cutout switch presence/function
		ARMGAURD CUTOFF	Displays/adjusts armgaurd cutout switch presence/function
		FLASH CODE	Displays/adjusts how fault flash codes are indicated
	CALIBRATIONS		
		CURRENT	Displays motor current calibration
		TEMPERATURE	Displays heatsink temperature calibration

2.26 PREVENTIVE MAINTENANCE AND INSPECTION SCHEDULE

The preventive maintenance and inspection checks are listed and defined in the following table. This table is divided into two basic parts, the AREA to be inspected and the INTERVAL at which the inspection is to take place. Under the AREA portion of the table, the various systems along with the components that make up that system are listed. The INTERVAL portion of the table is divided into five columns representing the various inspection time periods. The numbers listed within the interval column represent the applicable inspection code for which that component is to be checked.

The checks and services listed in this schedule are not intended to replace any local or regional regulations that may pertain to this type of equipment nor should the lists be considered as all inclusive. Variances in interval times may occur due to climate and/or conditions and depending on the location and use of the machine.

JLG Industries requires that a complete annual inspection be performed in accordance with the "Annual Machine Inspection Report" form. Forms are supplied with each new machine and are also available from JLG Customer Service. Form must be completed and returned to JLG Industries.

IMPORTANT

JLG INDUSTRIES REQUIRES THAT A COMPLETE ANNUAL INSPECTION BE PERFORMED IN ACCORDANCE WITH THE ANNUAL MACHINE INSPECTION REPORT FORM.

NOTE: *This machine requires periodic safety and maintenance inspections by a JLG dealer.*

The inspection and maintenance code numbers are as follows:

1. Check for proper and secure installation.
2. Check for visible damage and legibility.
3. Check for proper fluid level.
4. Check for any structural damage; cracked or broken welds; bent or warped surfaces.
5. Check for leakage.
6. Check for presence of excessive dirt or foreign material.
7. Check for proper operation and freedom of movement.
8. Check for excessive wear or damage. Check for proper tightness and adjustment.
9. Check for proper tightness and adjustment.
10. Drain, clean and refill.
11. Check for proper operation while pump/motor is running.
12. Check for proper lubrication.
13. Check for evidence of scratches, nicks or rust and for straightness of rod.
14. Check for condition of element; replace as necessary.
15. Check for proper inflation.

NOTE: **Inspection and Maintenance Code 10 to be performed every two years (800 hours).*

SECTION 2 - PROCEDURES

Table 2-10. Preventive Maintenance and Inspection Schedule

	Daily	Weekly	Monthly	3 Month	6 Month	1 Year
PLATFORM AREA						
Controller	1,11					
Switches	1,11					
Placards and Decals	1,2					
Control Tags	1,2					
Hose and Cable		4,8				
Wear Pads			8			
Handrail and Chains	1,4					
CHASIS AREA						
Batteries	3	5				
Battery Charger	1					
Hydraulic Pump/ Motor	1	5				
Valves	1	5				
Hydraulic Filter (See Lubrication Chart)		5				
Hydraulic hoses and tubing	1	5				
Hydraulic Oil Tank*	3	5	4			
Hydraulic Tank Breather		6				14
Lift Cylinder	1,12	5,6,13	4			
Limit Switch	1,7					
Placards and Decals	1,2					16
Wheel and Tire Assemblies	1	8		9		
Drive Motors		1,5,6				
Drive Brake		1,6	8			
Steer Cylinder	1	5,6,13	4			
Steer Components	1	4,6	8			12
Wheel Bearings			8			
Sizzor Arms	1,4					
Safety Prop	1,4					
Wear Pads			8			
Pivot Pins/Bolts	1,4		7,8			
Switches, Ground Control	1,11					
Control Tags	1,2					
Hose and Cable	1	4,8				
Pothole Protection System		1,7				

SECTION 3. TROUBLESHOOTING

3.1 GENERAL

This section contains troubleshooting information to be used for locating and correcting most of the operating problems which may develop in the aerial platform. If a problem should develop which is not presented in this section or which is not corrected by listed corrective actions, technically qualified guidance should be obtained before proceeding with any maintenance.

3.2 TROUBLESHOOTING INFORMATION

The troubleshooting procedures applicable to the aerial platform are listed and defined in Table 3-1, Electrical Troubleshooting, and Table 3-2, Hydraulic troubleshooting.

Each malfunction within an individual group or system is followed by a listing of probable causes which will enable determination of the applicable remedial action. The probable causes and remedial action should, where possible, be checked in the order listed in the tables.

It should be noted that there is no substitute for a thorough knowledge of the equipment and related systems.

It should be recognized that the majority of the problems arising in the machine will be centered in the hydraulic and electrical systems. For this reason, every effort has been made to ensure that all likely problems in these areas are given the fullest possible treatment. In the remaining machine groups, only those problems which have more than one probable cause and remedy are included. This means that problems for which the probable cause and remedy may be immediately obvious are not listed in this section.

The first rule for troubleshooting any circuit that is hydraulically operated and electrically controlled is to determine if the circuit is lacking hydraulic oil and electrical power. This can be ascertained by overriding the bypass valve (mechanically or electrically) so that oil is available to the function valve, then overriding the function valve mechanically. If the function performs satisfactorily, the problem exists with the control circuit.

3.3 HYDRAULIC CIRCUIT CHECKS

The first reference for improper function of a hydraulic system, where the cause is not immediately apparent, should be the troubleshooting chart. The best place to begin the problem analysis is at the power source (pump) Once it is determined that the pump is serviceable, then a systematic check of the circuit components, beginning with the control, would follow. For aid in troubleshooting, refer to the Illustrated Parts Manual for hydraulic diagram of the various circuits

SECTION 3 - TROUBLESHOOTING

Table 3-1. Electrical Troubleshooting Chart

TROUBLE	PROBABLE CAUSE	REMEDY
All machine functions do not operate		
	Emergency stop switch not activated	Activate Emergency stop switch
	Joystick not in neutral position	Release joystick, then select function
	Platform cable not connected to platform box or at base	Re-connect cable to platform box and check wiring at base
	Battery voltage out of range	
	If battery charger is plugged in	Check voltage with VOM. Unplug battery charger
	Battery voltage too low	Check voltage with VOM. Plug in battery charger
	Line contactor open circuit	
	Loose wiring connections on line contactor or at harness connection	Check wire terminations on line contactor and harness connection at base. Tighten connections as necessary
	Open coil on line contactor	Clean corrosion from line contactor
		Replace line contactor
	Faulty wiring at base	Repair or replace wiring as necessary
	Line contactor welded.	Replace the line contactor
	Line contactor or other driver short circuit or tripped	
	Point A short circuit	
	Motor stalled	Determine cause. Repair or replace motor as necessary
	Motor open circuit	
	Faulty motor	Replace motor
No drive function when platform fully lowered. Lift function okay		
	Malfunctioning limit switch	Use VOM to verify limit switch inputs. Adjust or repair malfunctioning limit switch
No drive function when platform elevated. Lift function okay		
	Malfunctioning limit switch	Use VOM to verify limit switch inputs. Adjust or repair malfunctioning limit switch
	Platform above drive cutout height	Lower platform below drive cutout height
Machine cannot lift down. Lift up function okay		
	Loose wiring on lift cylinder (s) at holding valve	Repair wiring on lift cylinder (s) at holding valve

Table 3-2. Hydraulic System Troubleshooting Chart

TROUBLE	PROBABLE CAUSE	REMEDY
Hydraulic pump noisy	Air bubbles in oil (reservoir too low.)	Replenish oil as necessary
	Oil filter dirty	Clean and/or replace filter as necessary
Pump cavitating. (Vacume in pump due to oil starvation)	Oil is reservoir too low	Replenish oil as necessary
	Restricted reservoir air vent	Clean vent
	Oil viscosity too high	Drain system and replace with recommended oil. Refer to Table 1-2, Hydraulic Oil
System overheating	Oil viscosity too high	Drain system and replace with recommended oil. Refer to Table 1-2, Hydraulic Oil

SECTION 3 - TROUBLESHOOTING

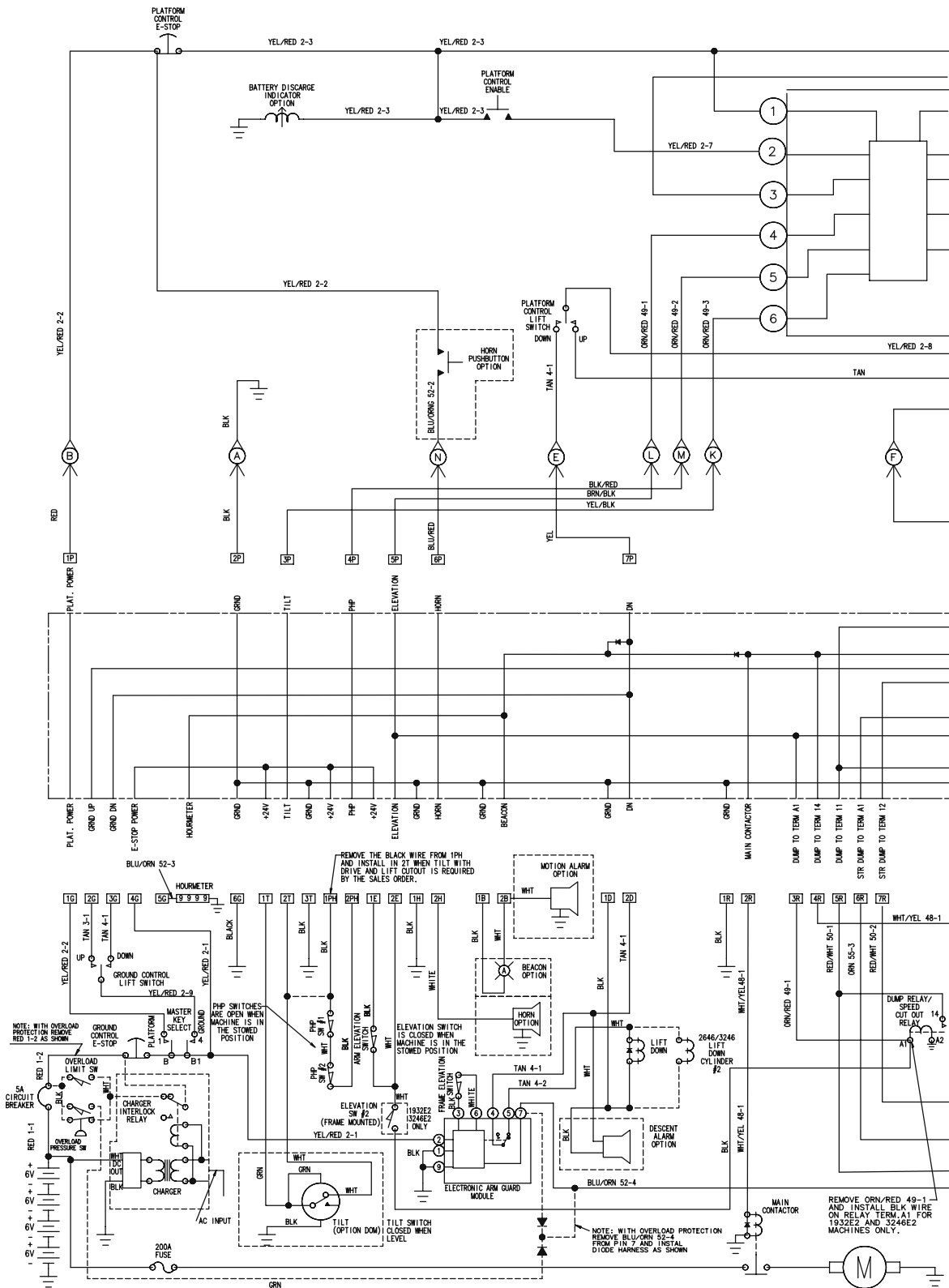
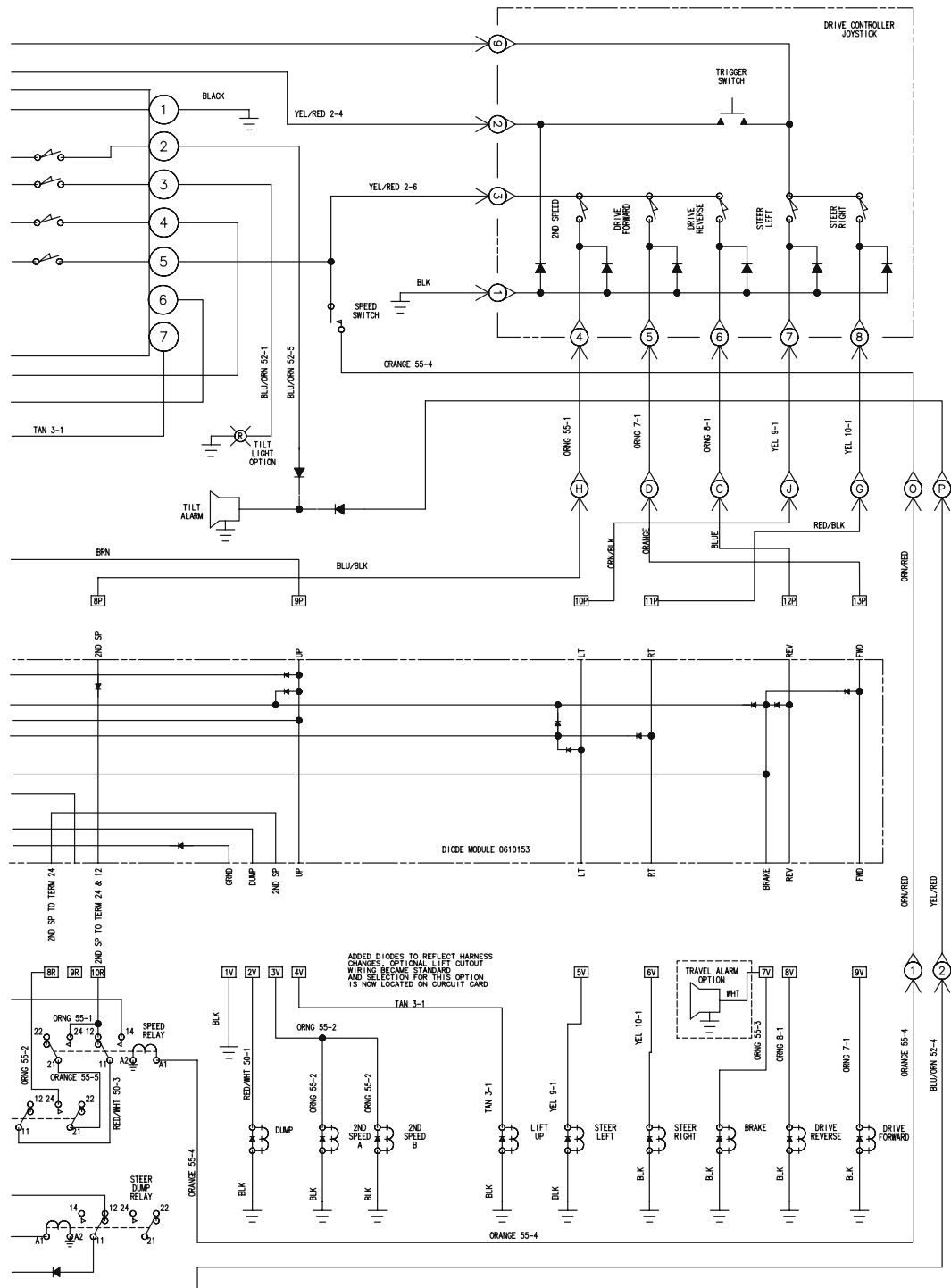

Figure 3-1. Electrical Schematic - Non Proportional Control (Sheet 1 of 2)



1870117 C

Figure 3-2. Electrical Schematic - Non Proportional Control (Sheet 2 of 2)

SECTION 3 - TROUBLESHOOTING

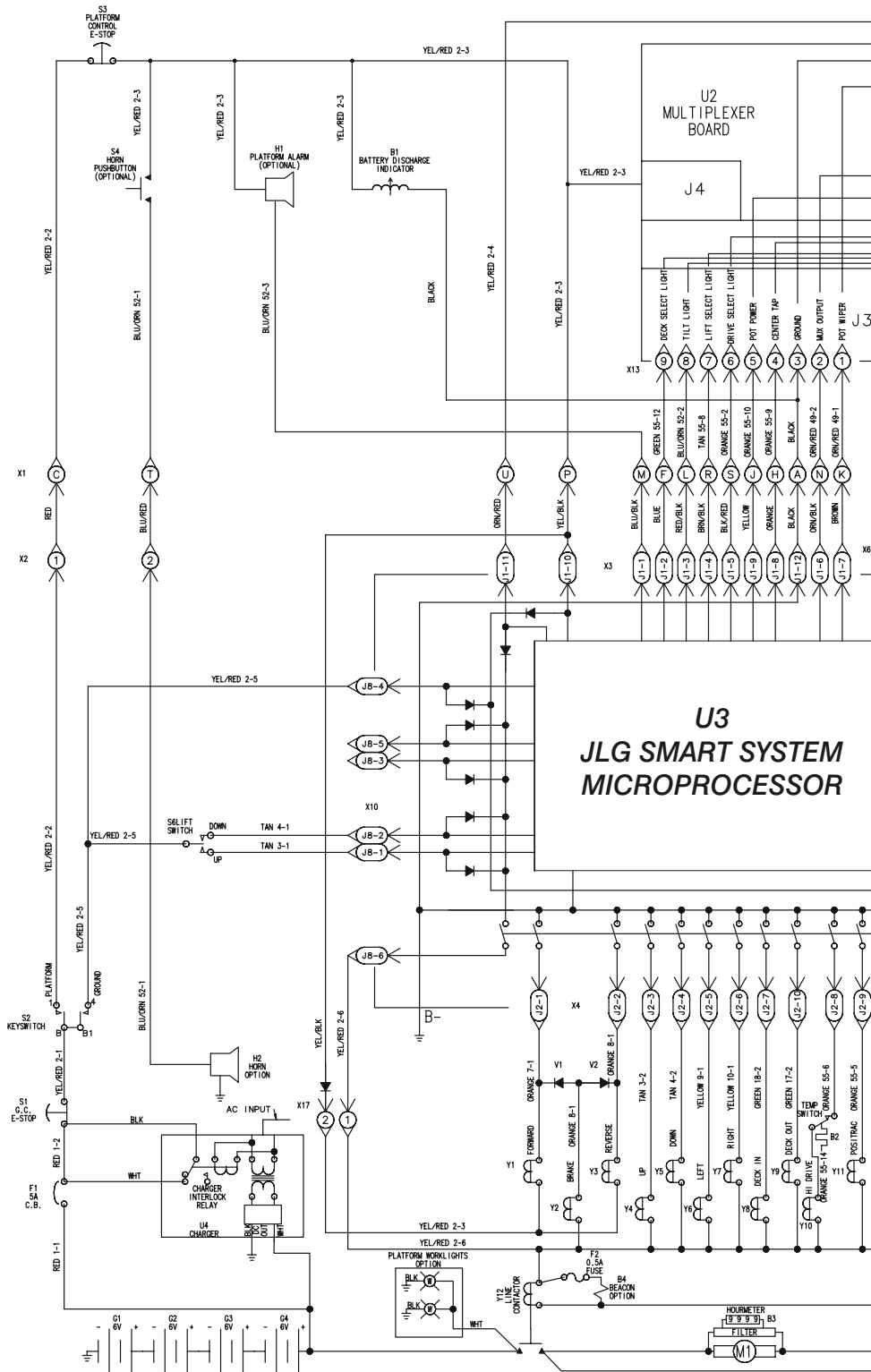

Figure 3-3. Electrical Schematic - Proportional Control (Sheet 1 of 2)

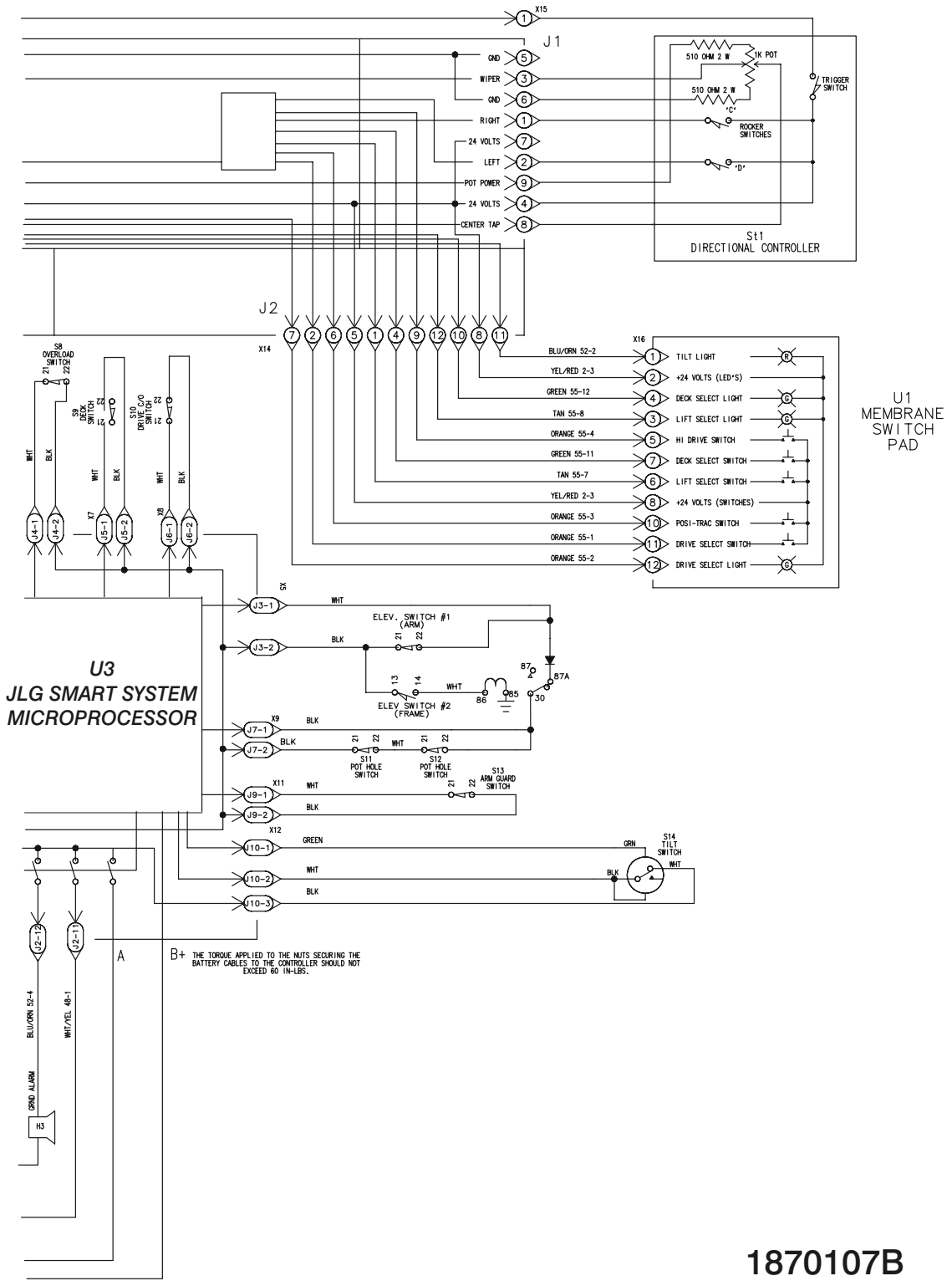

Figure 3-4. Electrical Schematic - Proportional Control (Sheet 2 of 2)

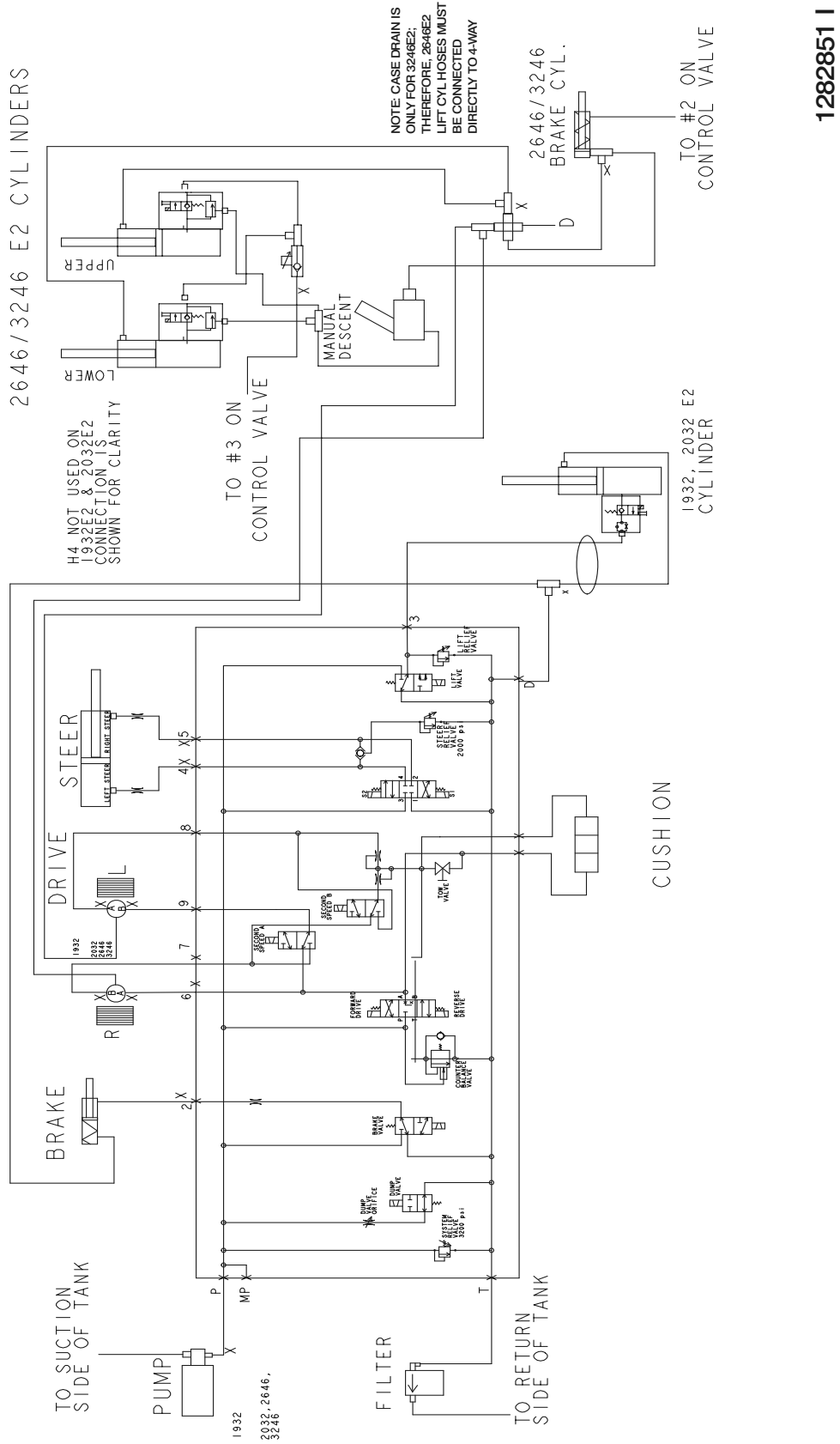
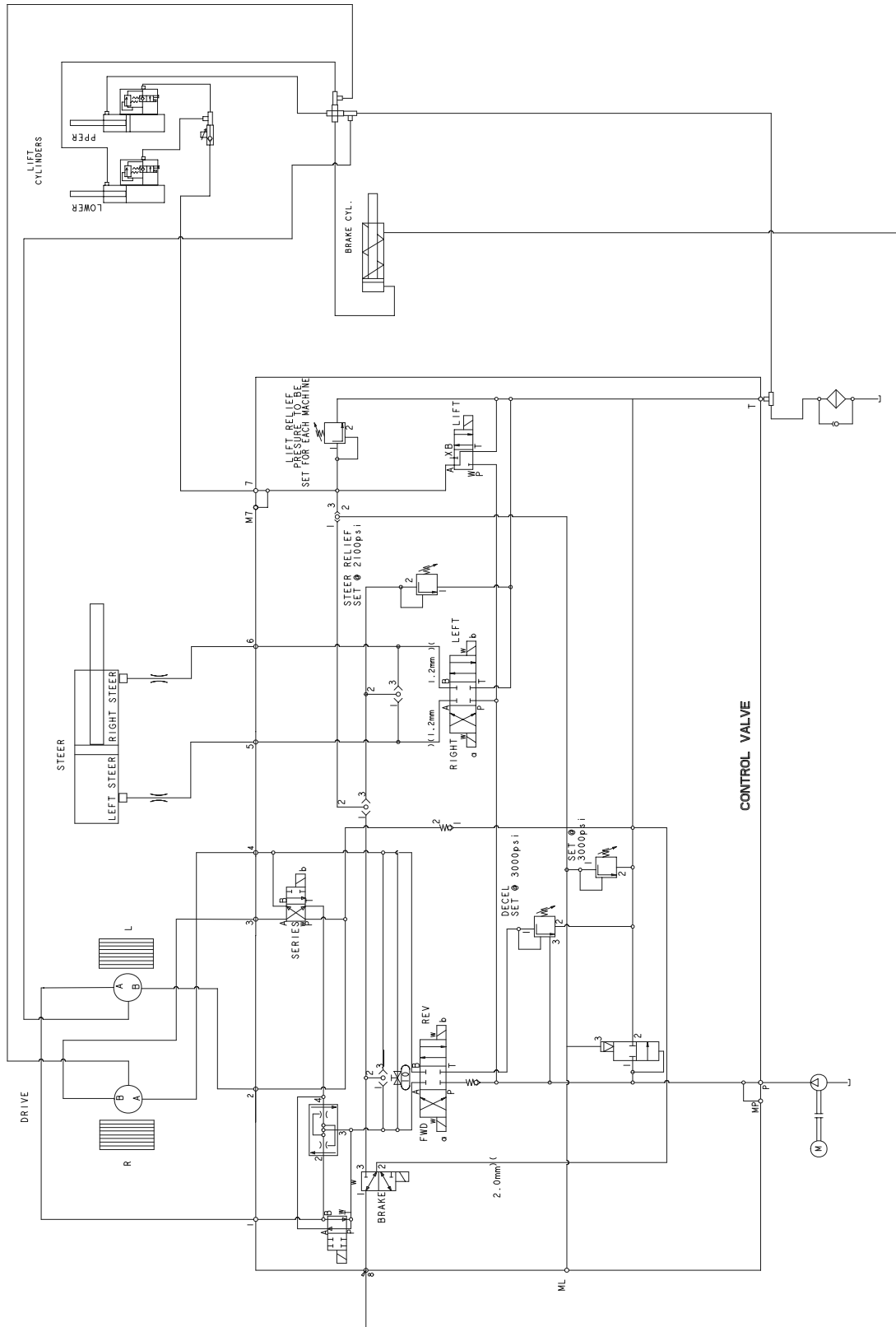

Figure 3-5. Hydraulic Schematic - Non Proportional Drive



2792399 B

Figure 3-6. Hydraulic Schematic - 3246E2 Proportional Control

SECTION 3 - TROUBLESHOOTING

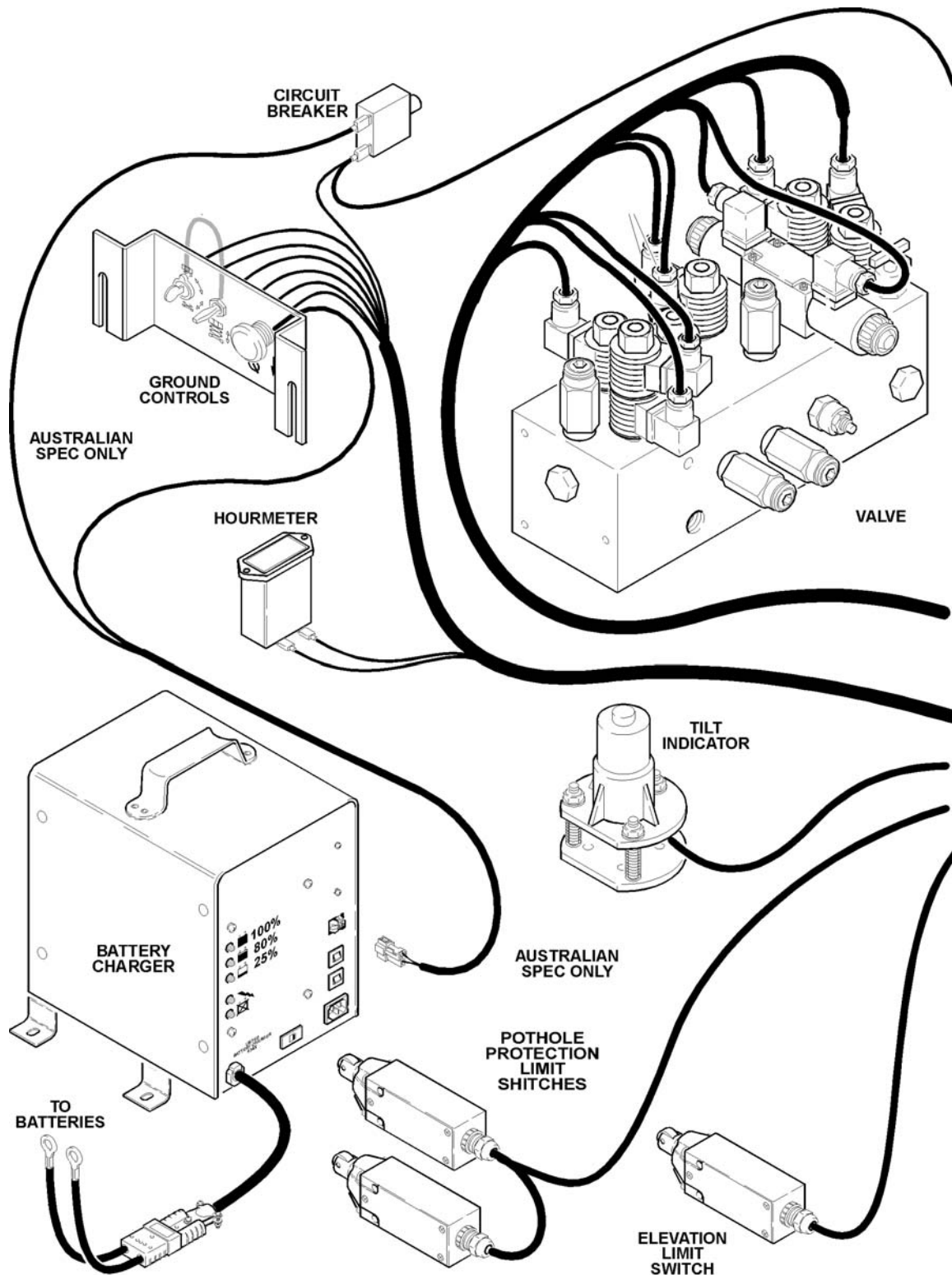

Figure 3-7. Harness and Cable Assembly - Non Proportional Control (Sheet 1 of 2)

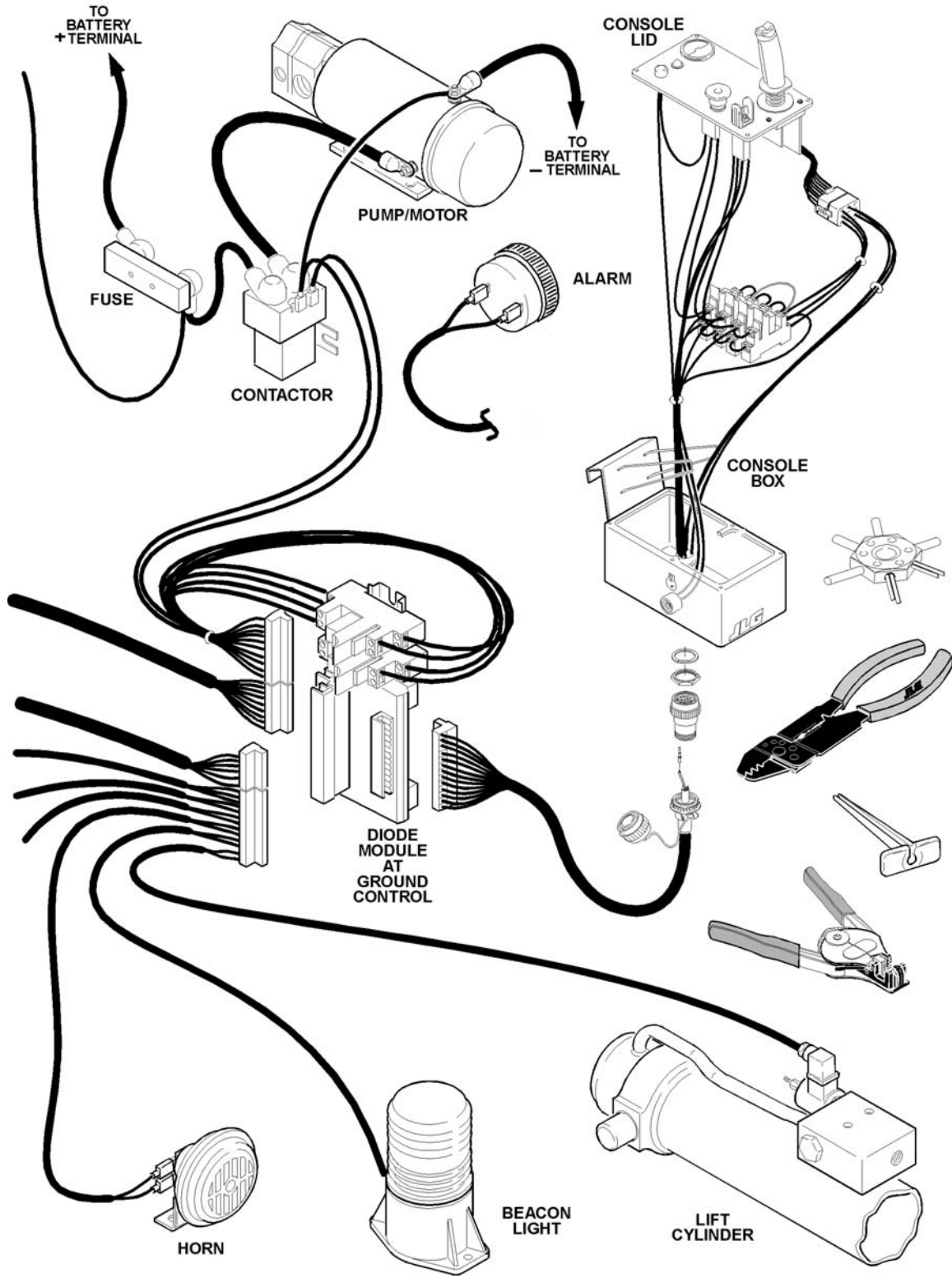

Figure 3-8. Harness and Cable Assembly - Non Proportional Control (Sheet 2 of 2)

This page left blank intentionally.



Corporate Office
JLG Industries, Inc.
1 JLG Drive
McConnellsburg PA. 17233-9533
USA
Phone: (717) 485-5161
Fax: (717) 485-6417

JLG Worldwide Locations

JLG Industries (Australia)
P.O. Box 5119
11 Bolwarra Road
Port Macquarie
N.S.W. 2444
Australia
Phone: (61) 2 65 811111
Fax: (61) 2 65 810122

JLG Industries (UK)
Unit 12, Southside
Bredbury Park Industrial Estate
Bredbury
Stockport
SK6 2sP
England
Phone: (44) 870 200 7700
Fax: (44) 870 200 7711

JLG Deutschland GmbH
Max Planck Strasse 21
D-27721 Ritterhude/Ihlpohl
Bei Bremen
Germany
Phone: (49) 421 693 500
Fax: (49) 421 693 5035

JLG Industries (Italia)
Via Po. 22
20010 Pregnana Milanese - MI
Italy
Phone: (39) 02 9359 5210
Fax: (39) 02 9359 5845

JLG Latino Americana Ltda.
Rua Eng. Carlos Stevenson,
80-Suite 71
13092-310 Campinas-SP
Brazil
Phone: (55) 19 3295 0407
Fax: (55) 19 3295 1025

JLG Europe B.V.
Jupiterstraat 234
2132 HJ Foofddorp
The Netherlands
Phone: (31) 23 565 5665
Fax: (31) 23 557 2493

JLG Industries (Norge AS)
Sofeimyrveien 12
N-1412 Sofienyr
Norway
Phone: (47) 6682 2000
Fax: (47) 6682 2001

JLG Polska
Ul. Krolewska
00-060 Warszawa
Poland
Phone: (48) 91 4320 245
Fax: (48) 91 4358 200

JLG Industries (Europe)
Kilmartin Place,
Tannochside Park
Uddingston G71 5PH
Scotland
Phone: (44) 1 698 811005
Fax: (44) 1 698 811055

JLG Industries (Pty) Ltd.
Unit 1, 24 Industrial Complex
Herman Street
Meadowdale
Germiston
South Africa
Phone: (27) 11 453 1334
Fax: (27) 11 453 1342

Plataformas Elevadoras
JLG Iberica, S.L.
Trapadella, 2
P.I. Castellbisbal Sur
08755Castellbisbal
Spain
Phone: (34) 93 77 24700
Fax: (34) 93 77 11762

JLG Industries (Sweden)
Enkopingsvagen 150
Box 704
SE - 175 27 Jarfalla
Sweden
Phone: (46) 8 506 59500
Fax: (46) 8 506 59534
